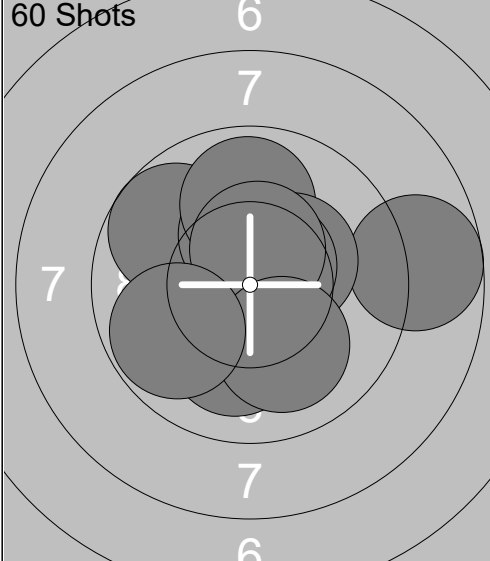
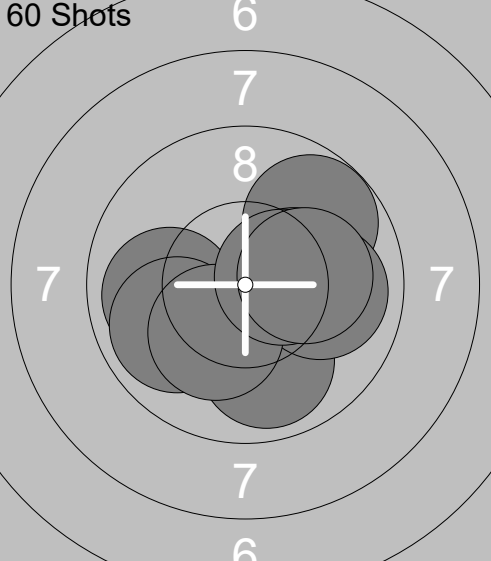
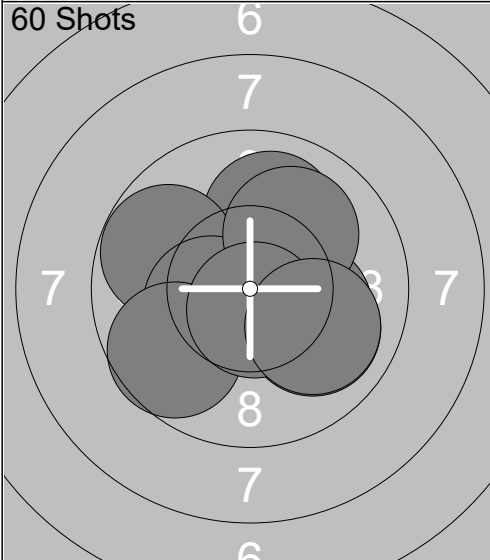
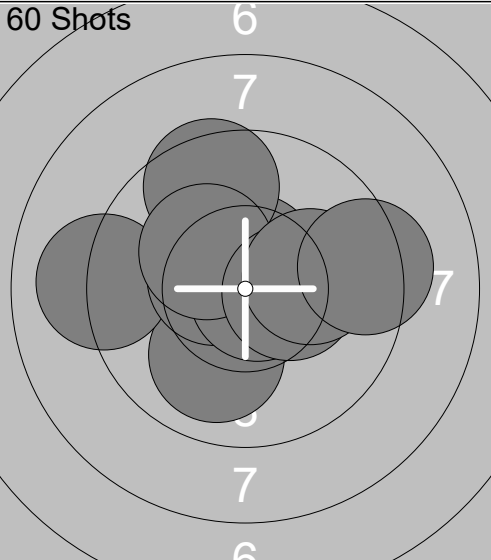
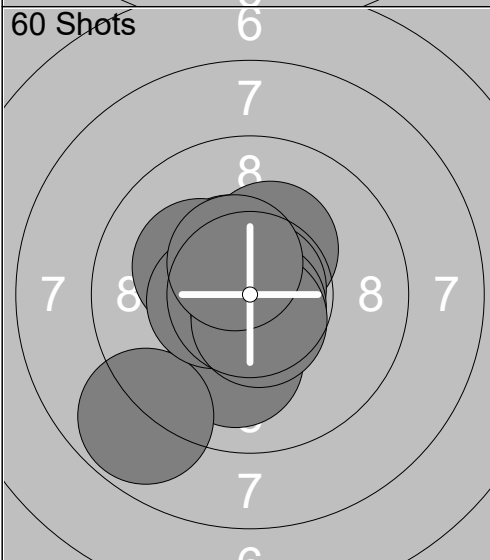
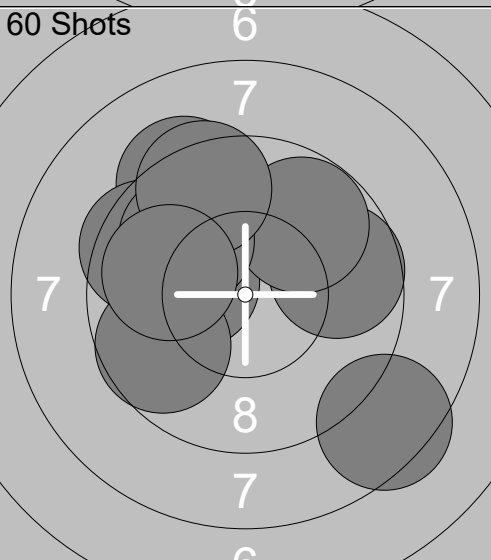

<p>60 Shots</p> 	<p>1: 10.1 ↓ 2: 9.7 ↖ 3: 10.3x ↑ 4: 9.9 ↑ 5: 8.7 → 6: 10.3x ↗ 7: 10.6x ↗ 8: 10.5x ↑ 9: 10.1 ↓ 10: 9.8 ↖</p> <p>Series 100.0 100.0</p>	<p>60 Shots</p> 	<p>11: 10.5x ⇒ 12: 9.9 ↓ 13: 9.8 ↗ 14: 9.9 ← 15: 10.3x → 16: 10.0 → 17: 9.9 ↖ 18: 10.2x ↓ 19: 10.4x → 20: 10.2x →</p> <p>Series 101.1 201.1</p>
<p>60 Shots</p> 	<p>21: 10.0 ↑ 22: 10.3x ← 23: 10.2x ⇒ 24: 9.8 ↖ 25: 10.4x ← 26: 9.7 ↖ 27: 10.0 ⇒ 28: 10.1 ↗ 29: 10.7x ↓ 30: 10.0 ⇒</p> <p>Series 101.2 302.3</p>	<p>60 Shots</p> 	<p>31: 10.6x ↑ 32: 10.0 ↓ 33: 9.5 ↑ 34: 9.1 ← 35: 10.5x ← 36: 10.8x ⇒ 37: 10.2x ↖ 38: 10.4x → 39: 10.1 → 40: 9.3 →</p> <p>Series 100.5 402.8</p>
<p>60 Shots</p> 	<p>41: 10.5x ↗ 42: 10.3x ↑ 43: 10.1 ↓ 44: 10.2x ↖ 45: 10.8x ↗ 46: 8.8 ↖ 47: 10.5x ← 48: 10.8x ↓ 49: 10.6x ↓ 50: 10.5x ↑</p> <p>Series 103.1 505.9</p>	<p>60 Shots</p> 	<p>51: 10.2x ← 52: 9.7 ↖ 53: 9.3 ↑ 54: 9.5 ↖ 55: 9.7 → 56: 9.8 ↗ 57: 9.9 ↗ 58: 9.4 ↑ 59: 8.4 ↓ 60: 9.9 ←</p> <p>Series 95.8 601.7</p>

Relay 6	Lane 3	Jessica Gregory
-------------------	------------------	------------------------

WVU Mobile Range		
------------------	--	--

18.11.2023	Walther Cup 2023	West Virginia University
------------	------------------	--------------------------

Comment	Signature
---------	-----------

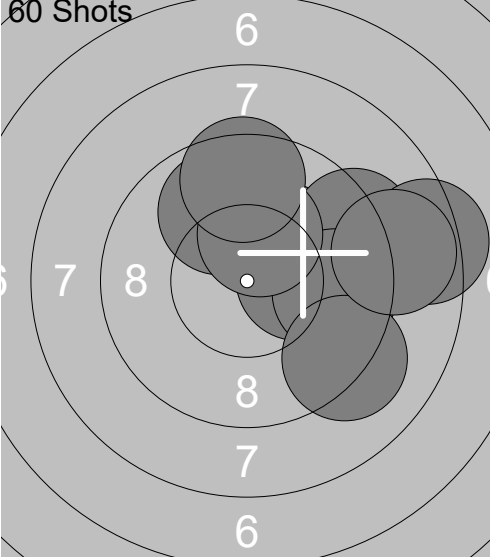
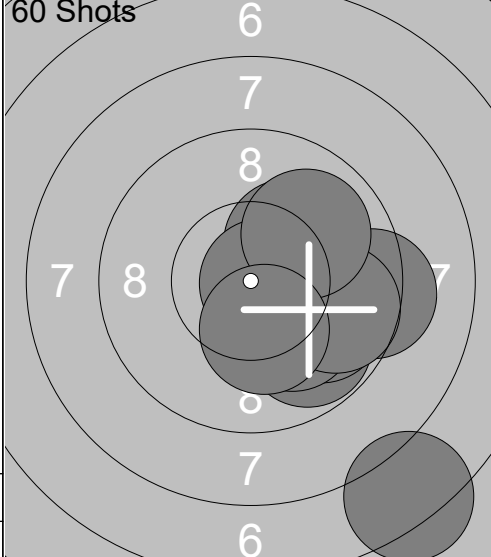
	1: 9.9 ↗		11: 7.3 ↘
	2: 10.2x ↗		12: 9.8 ↘
	3: 10.2x →		13: 9.9 ↘
	4: 9.3 →		14: 10.2x ↗
	5: 9.7 →		15: 10.8x →
	6: 8.3 →		16: 9.3 →
	7: 9.2 ↘		17: 10.1 ↘
	8: 10.2x ↑		18: 9.7 →
	9: 9.5 ↑		19: 9.9 ↗
	10: 8.8 →		20: 10.3x ↘
	Series 95.3		Series 97.3
	95.3		192.6

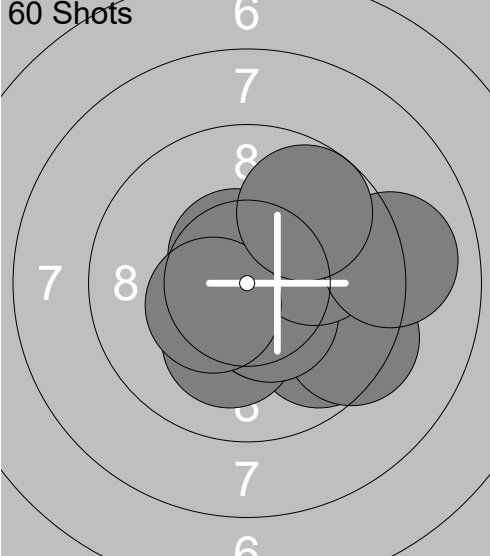
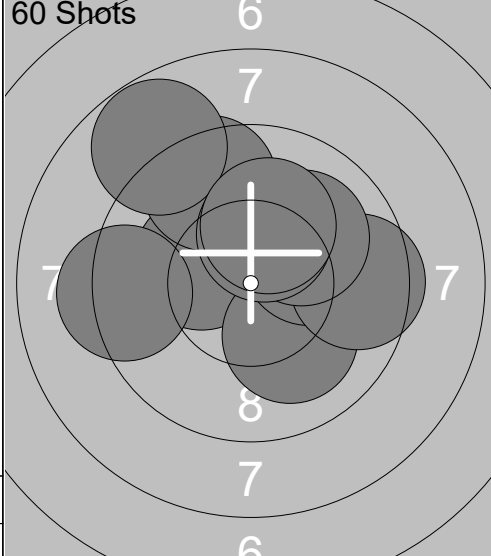
	21: 9.7 ↘		31: 10.2x ↖
	22: 10.2x ↘		32: 10.1 ↘
	23: 10.5x ↘		33: 10.1 →
	24: 9.4 →		34: 9.5 →
	25: 10.4x ↘		35: 10.0 ↗
	26: 10.6x ↑		36: 9.3 ←
	27: 10.0 →		37: 9.5 ↑
	28: 10.4x ↖		38: 8.8 ↗
	29: 9.0 →		39: 10.3x ↑
	30: 9.7 ↗		40: 10.2x ↑
	Series 99.9		Series 98.0
	292.5		390.5

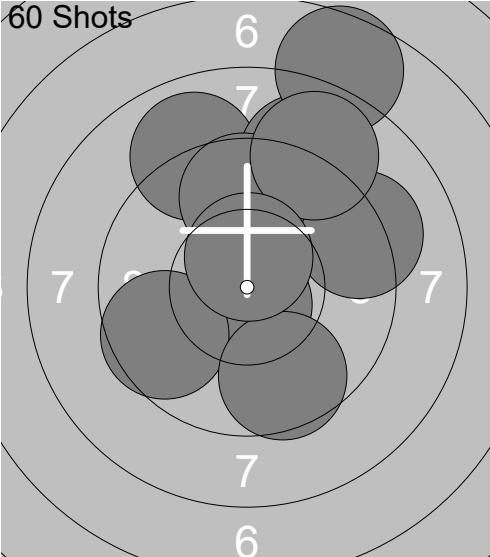
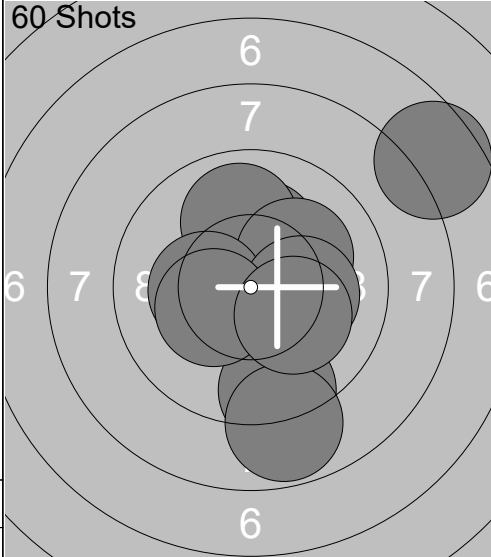
	41: 10.7x ↘		51: 10.2x ↑
	42: 9.0 ↑		52: 9.9 ↑
	43: 9.0 ↑		53: 9.3 ↘
	44: 9.2 →		54: 10.1 ↗
	45: 9.6 ←		55: 7.6 ↗
	46: 7.6 ↑		56: 10.3x ←
	47: 9.7 ↑		57: 10.2x →
	48: 8.9 ↗		58: 8.8 ↘
	49: 9.6 ↘		59: 10.3x ↖
	50: 10.5x ↑		60: 10.2x ↘
	Series 93.8		Series 96.9
	484.3		581.2

Relay 6	Lane 4	Elizabeth Whiteman
--------------------------	-------------------------	---------------------------

WVU Mobile Range			
------------------	--	--	--

18.11.2023	Walther Cup 2023	West Virginia University
------------	------------------	--------------------------

Comment	Signature
---------	-----------

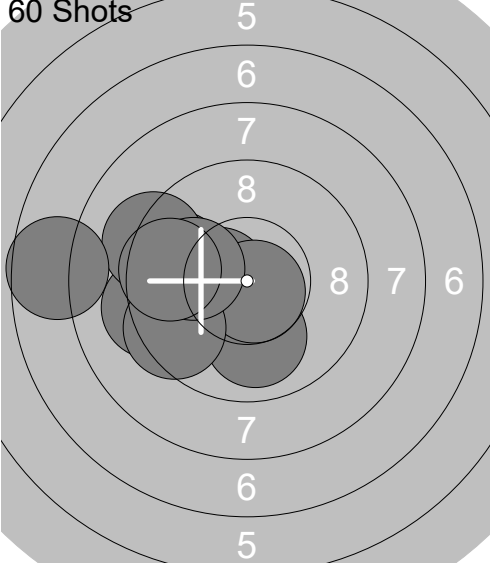
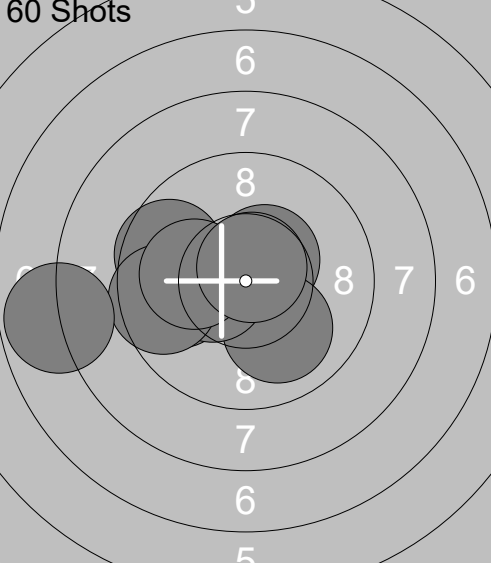
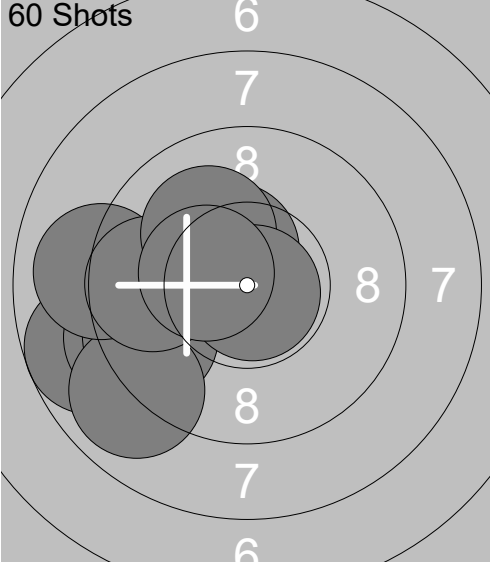
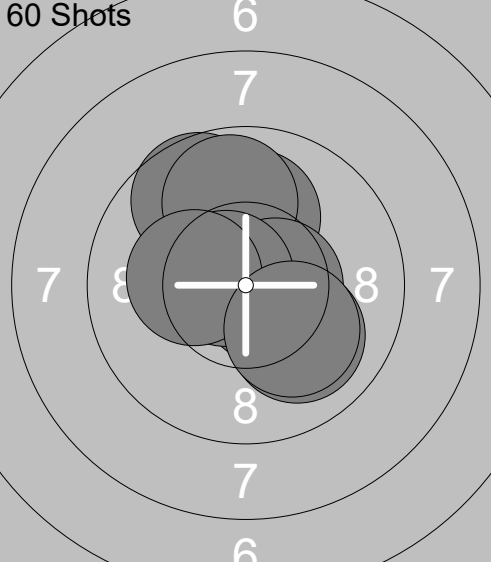
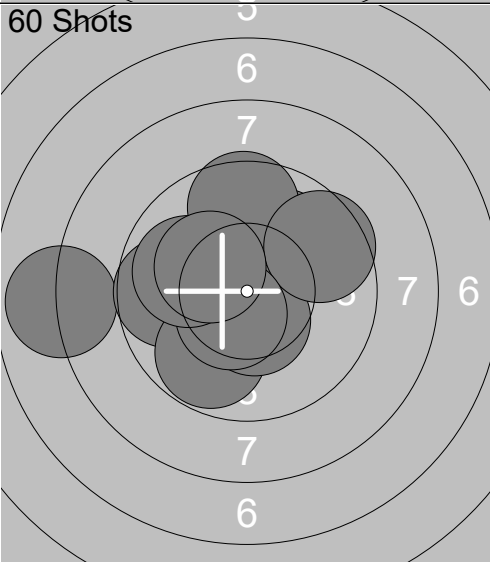
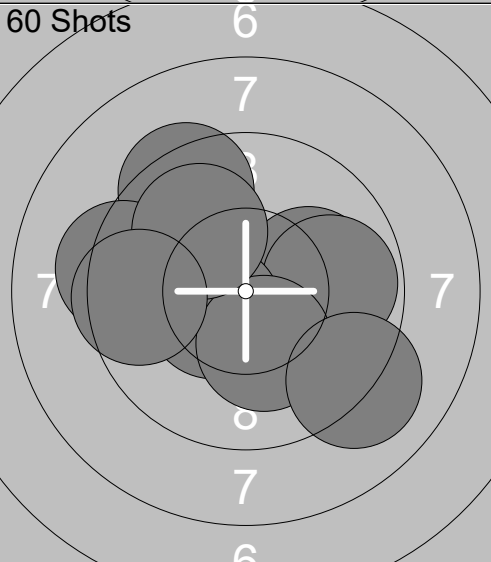
<p>60 Shots</p> 	<p>1: 10.0 ↓ 2: 10.4x ← 3: 10.7x ↓ 4: 9.2 ← 5: 9.7 ← 6: 9.4 ← 7: 9.2 ← 8: 10.0 ← 9: 7.6 ← 10: 9.6 ←</p> <p>Series 95.8 95.8</p>	<p>60 Shots</p> 	<p>11: 10.5x ↗ 12: 10.0 ↓ 13: 10.2x ← 14: 9.8 ← 15: 9.6 ← 16: 10.4x ← 17: 9.6 ← 18: 7.8 ← 19: 10.1 ← 20: 10.7x ↗</p> <p>Series 98.7 194.5</p>
<p>60 Shots</p> 	<p>21: 8.7 ← 22: 9.3 ← 23: 9.5 ← 24: 8.9 ↓ 25: 9.0 ← 26: 9.7 ← 27: 10.4x ↗ 28: 10.1 ↗ 29: 10.8x ↓ 30: 10.4x ←</p> <p>Series 96.8 291.3</p>	<p>60 Shots</p> 	<p>31: 10.1 ↗ 32: 9.7 ↗ 33: 10.0 ↑ 34: 10.6x ⇒ 35: 9.8 ↑ 36: 10.6x ⇒ 37: 10.0 ↓ 38: 10.7x ← 39: 10.3x ← 40: 10.1 ↓</p> <p>Series 101.9 393.2</p>
<p>60 Shots</p> 	<p>41: 7.9 ← 42: 9.7 ← 43: 9.8 ↓ 44: 10.0 ↗ 45: 9.6 ↑ 46: 10.5x ↓ 47: 9.6 ↗ 48: 10.5x ↓ 49: 9.9 ← 50: 10.2x ←</p> <p>Series 97.7 490.9</p>	<p>60 Shots</p> 	<p>51: 9.4 ↗ 52: 10.6x ↓ 53: 10.1 ⇒ 54: 9.3 ← 55: 9.8 ⇒ 56: 10.5x ← 57: 10.2x ↓ 58: 9.9 ↗ 59: 9.5 ← 60: 9.1 ↓</p> <p>Series 98.4 589.3</p>

Relay 6	Lane 5	Charles Meyer
--------------------------	-------------------------	----------------------

WVU Mobile Range			
------------------	--	--	--

18.11.2023	Walther Cup 2023	West Virginia University
------------	------------------	--------------------------

Comment	Signature
---------	-----------

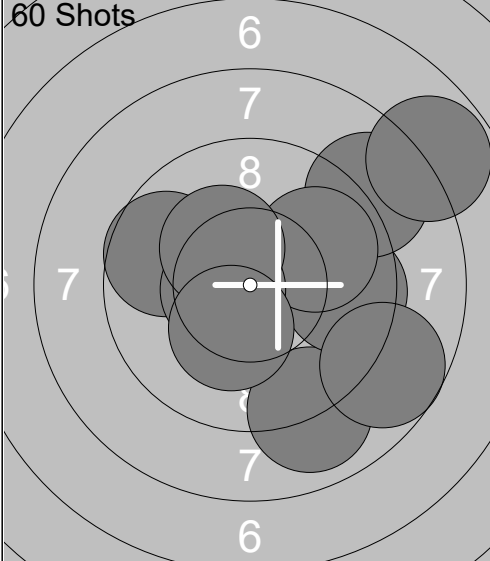
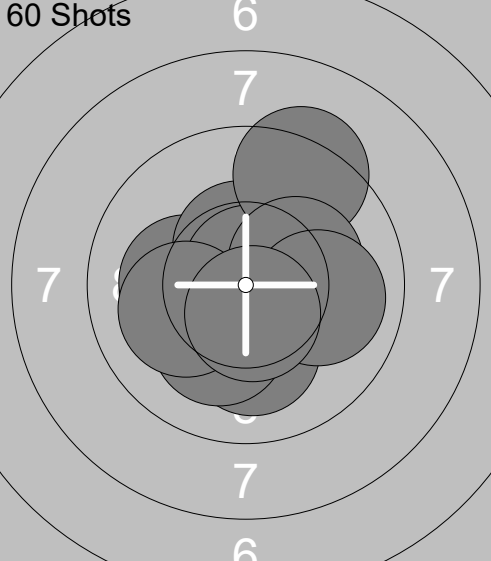
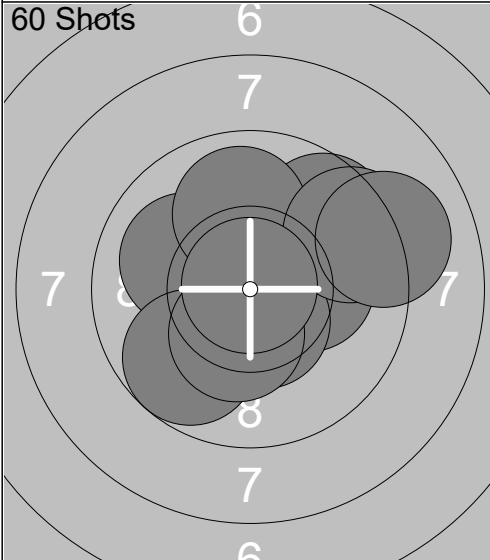
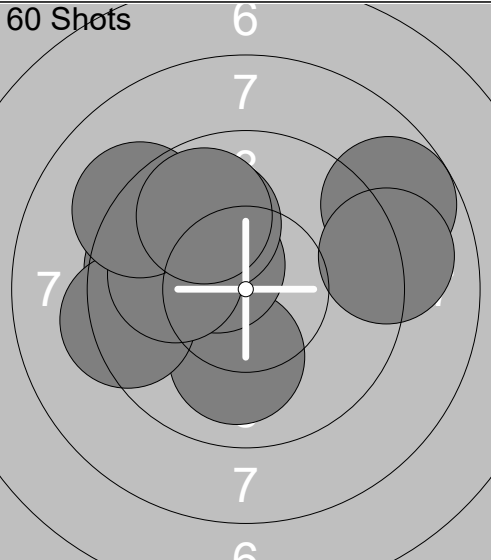
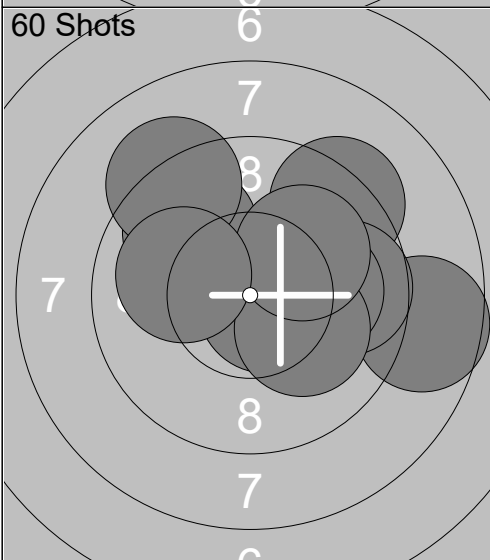
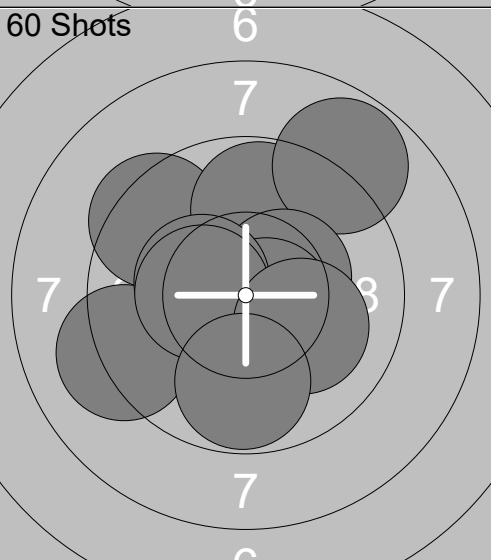
60 Shots 	1: 9.0 ↓ 2: 9.6 → 3: 8.8 ↗ 4: 9.9 ↗ 5: 8.7 ↘ 6: 7.8 ↗ 7: 9.7 ← 8: 10.6x ← 9: 10.3x ↗ 10: 10.3x ↓ <hr/> Series 94.7 94.7	60 Shots 	11: 10.2x ← 12: 10.1 ↓ 13: 10.2x ↓ 14: 10.5x ↑ 15: 10.8x ↑ 16: 9.3 ↑ 17: 10.2x → 18: 10.1 ← 19: 10.0 → 20: 10.6x ↓ <hr/> Series 102.0 196.7
60 Shots 	21: 10.2x → 22: 10.0 ← 23: 9.8 ↓ 24: 10.5x ↓ 25: 9.6 ↗ 26: 9.9 ↑ 27: 9.4 ↗ 28: 10.3x ↓ 29: 9.1 → 30: 10.9x ↑ <hr/> Series 99.7 296.4	60 Shots 	31: 10.1 ↓ 32: 8.7 ↗ 33: 9.0 → 34: 10.5x ↗ 35: 9.7 ← 36: 9.3 ← 37: 10.0 ↑ 38: 10.0 ← 39: 9.2 ↗ 40: 9.8 ↑ <hr/> Series 96.3 392.7
60 Shots 	41: 8.6 → 42: 9.3 ↗ 43: 9.7 → 44: 10.7x ↘ 45: 10.1 → 46: 9.8 ↗ 47: 9.2 ↗ 48: 10.1 ↘ 49: 10.1 ↗ 50: 10.0 ← <hr/> Series 97.6 490.3	60 Shots 	51: 9.4 ↗ 52: 9.8 ↑ 53: 8.8 ↗ 54: 10.4x → 55: 9.2 ← 56: 10.6x ↘ 57: 10.3x ← 58: 10.4x ← 59: 10.1 ↘ 60: 9.8 ↓ <hr/> Series 98.8 589.1

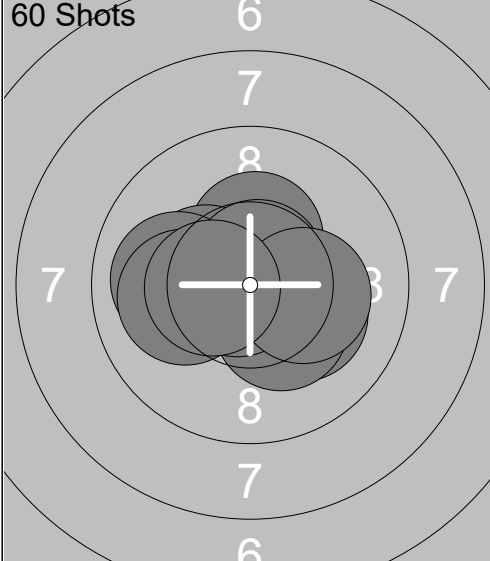
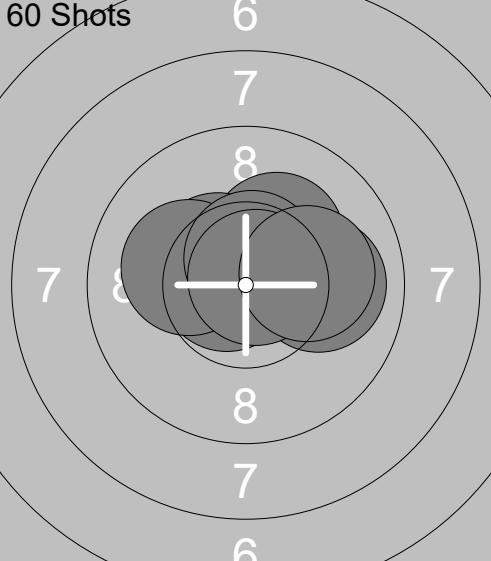
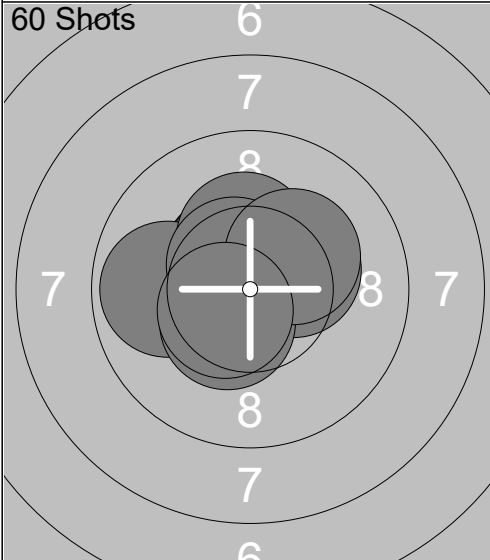
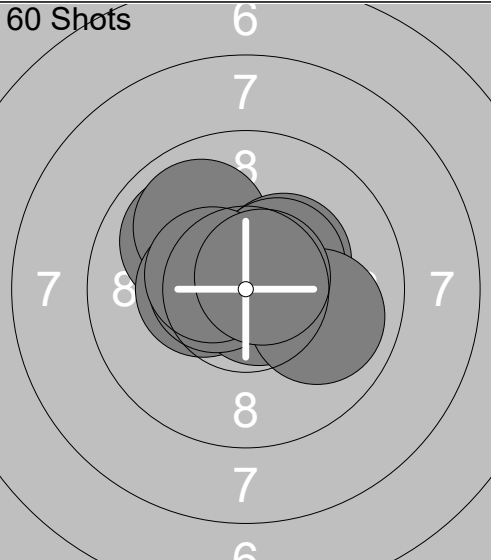
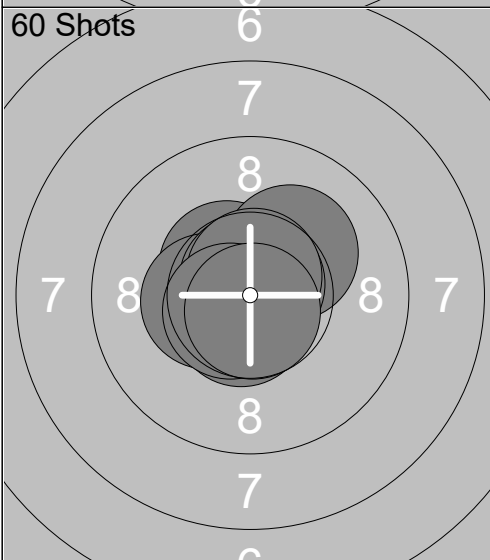
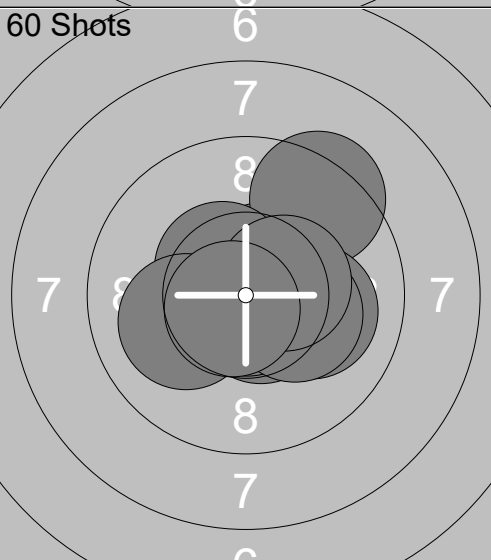
<p>60 Shots</p> 	<p>1: 10.2x ➤ 2: 10.3x ▼ 3: 10.3x ↑ 4: 10.3x ← 5: 10.0 ← 6: 10.1 ← 7: 10.8x ← 8: 10.7x ↑ 9: 10.2x ➤ 10: 10.4x ←</p> <p>Series 103.3 103.3</p>	<p>60 Shots</p> 	<p>11: 10.7x ↙ 12: 10.2x ↗ 13: 10.7x ← 14: 10.0 → 15: 10.5x ↙ 16: 10.2x ← 17: 10.5x ➤ 18: 10.6x ↑ 19: 10.8x ➤ 20: 10.1 →</p> <p>Series 104.3 207.6</p>
<p>60 Shots</p> 	<p>21: 10.3x ➤ 22: 10.5x ↙ 23: 10.6x ← 24: 10.5x ↗ 25: 9.9 ← 26: 10.3x ↑ 27: 10.6x ↗ 28: 10.4x ▼ 29: 10.2x ➤ 30: 10.5x ↙</p> <p>Series 103.8 311.4</p>	<p>60 Shots</p> 	<p>31: 10.0 ↙ 32: 9.9 ↙ 33: 10.3x ➤ 34: 10.4x ← 35: 10.4x ➤ 36: 10.7x ▼ 37: 10.6x ← 38: 9.9 ➤ 39: 10.5x ← 40: 10.7x ➤</p> <p>Series 103.4 414.8</p>
<p>60 Shots</p> 	<p>41: 10.6x ▼ 42: 10.5x ↙ 43: 10.4x ← 44: 10.8x ↑ 45: 10.2x ➤ 46: 10.8x ↗ 47: 10.9x ↙ 48: 10.7x ↑ 49: 10.6x ↙ 50: 10.7x ▼</p> <p>Series 106.2 521.0</p>	<p>60 Shots</p> 	<p>51: 10.6x ▼ 52: 10.5x ↗ 53: 9.4 ↗ 54: 10.1 → 55: 10.5x ↙ 56: 10.1 ← 57: 10.8x ▼ 58: 10.3x ➤ 59: 10.4x ➤ 60: 10.7x ↙</p> <p>Series 103.4 624.4</p>

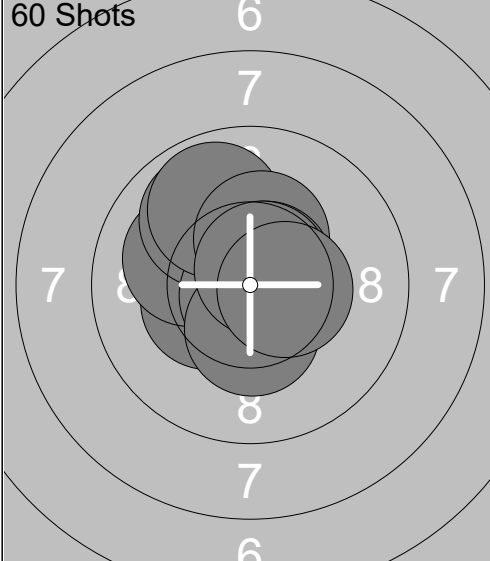
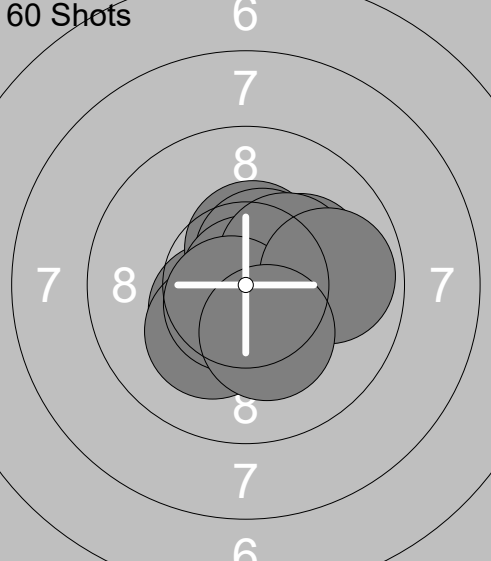
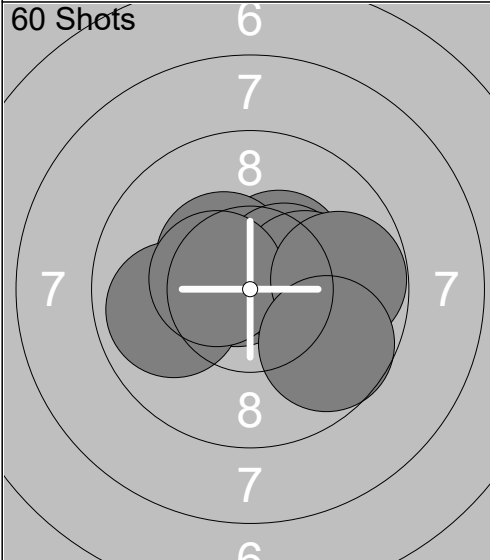
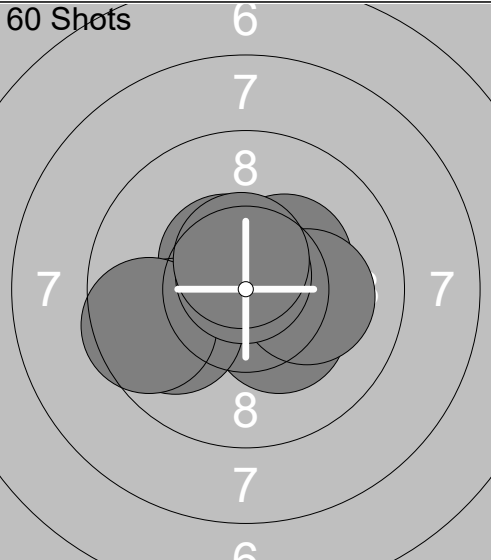
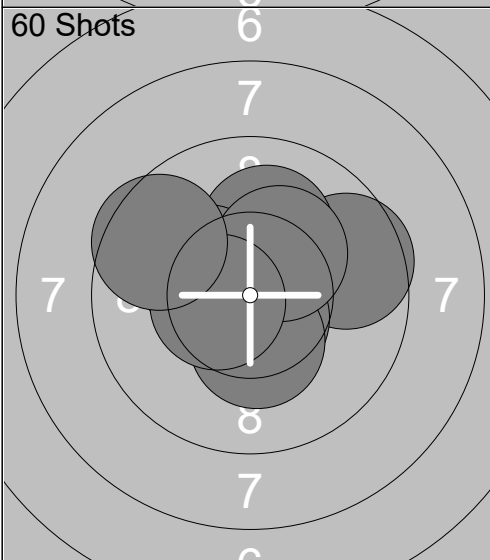
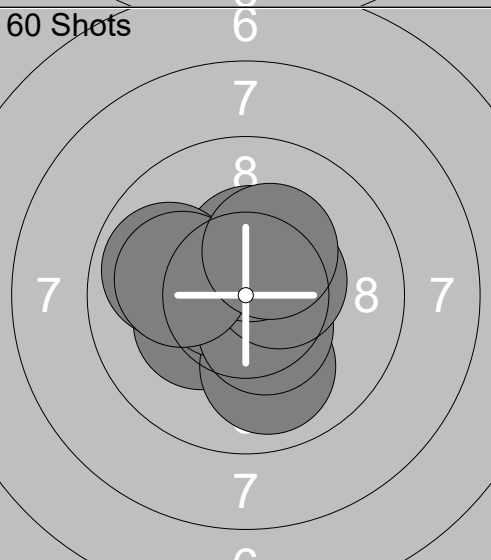
<p>60 Shots</p> 	<p>1: 10.4x ← 2: 10.1 ← 3: 9.9 ↗ 4: 10.8x ↓ 5: 9.9 ↗ 6: 10.3x ↑ 7: 10.7x ↗ 8: 10.4x ↓ 9: 10.7x ↗ 10: 10.5x →</p> <p>Series 103.7 103.7</p>	<p>60 Shots</p> 	<p>11: 10.4x ↙ 12: 10.5x ↑ 13: 10.5x ↗ 14: 10.2x ↙ 15: 10.9x ↗ 16: 10.2x → 17: 10.3x ↗ 18: 10.6x ↙ 19: 9.9 → 20: 10.3x ↘</p> <p>Series 103.8 207.5</p>
<p>60 Shots</p> 	<p>21: 10.3x → 22: 10.7x ↖ 23: 10.4x ↗ 24: 10.4x ↖ 25: 10.4x ↗ 26: 10.2x → 27: 9.9 ← 28: 10.5x ← 29: 9.8 → 30: 9.7 ↘</p> <p>Series 102.3 309.8</p>	<p>60 Shots</p> 	<p>31: 10.6x ↖ 32: 10.9x → 33: 10.3x ↘ 34: 10.3x ↗ 35: 10.1 → 36: 10.5x ↖ 37: 9.9 ← 38: 9.6 ← 39: 10.8x ↑ 40: 10.6x ↑</p> <p>Series 103.6 413.4</p>
<p>60 Shots</p> 	<p>41: 9.6 → 42: 10.6x ↘ 43: 10.2x ↖ 44: 10.6x ← 45: 10.3x ↓ 46: 10.1 ↑ 47: 10.3x ↖ 48: 10.3x ↗ 49: 10.5x ← 50: 9.6 ↖</p> <p>Series 102.1 515.5</p>	<p>60 Shots</p> 	<p>51: 10.5x ← 52: 10.3x ↙ 53: 10.0 ↓ 54: 10.7x ← 55: 10.5x ↘ 56: 10.5x → 57: 10.4x ↑ 58: 9.9 ← 59: 10.1 ← 60: 10.3x ↗</p> <p>Series 103.2 618.7</p>

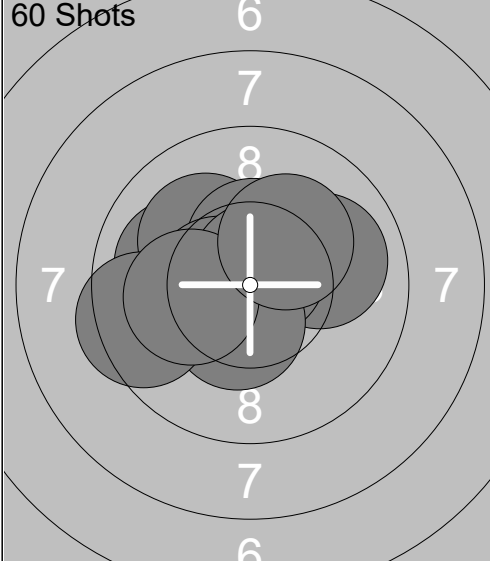
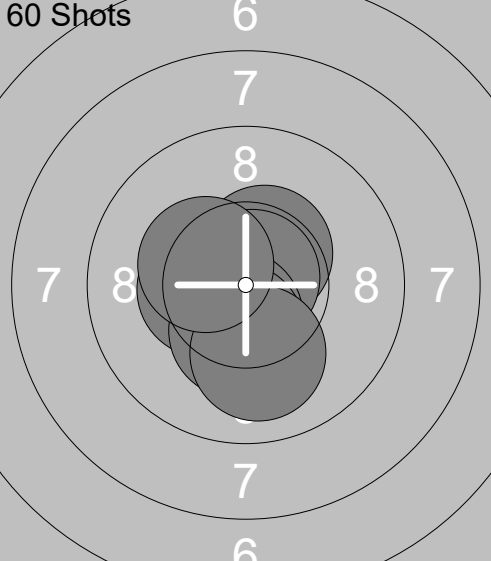
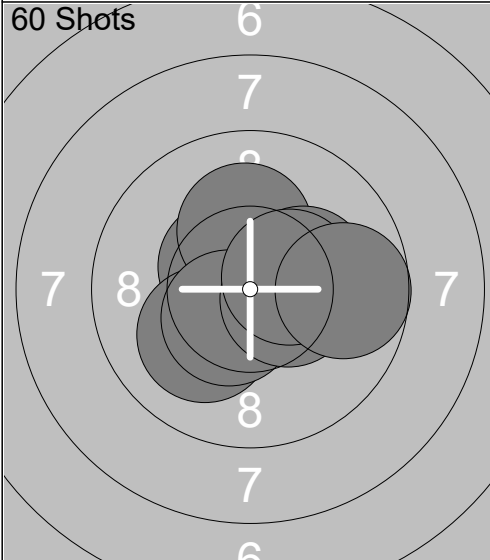
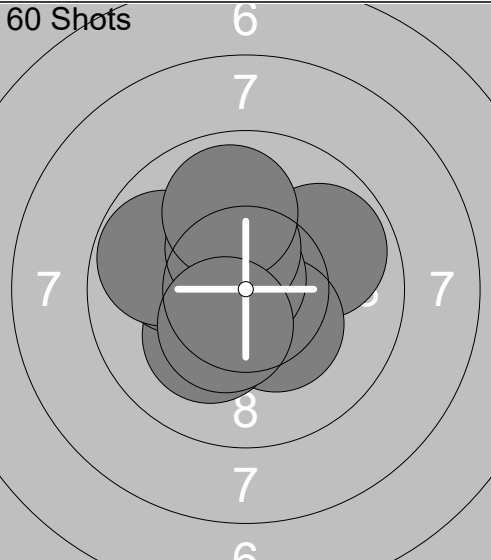
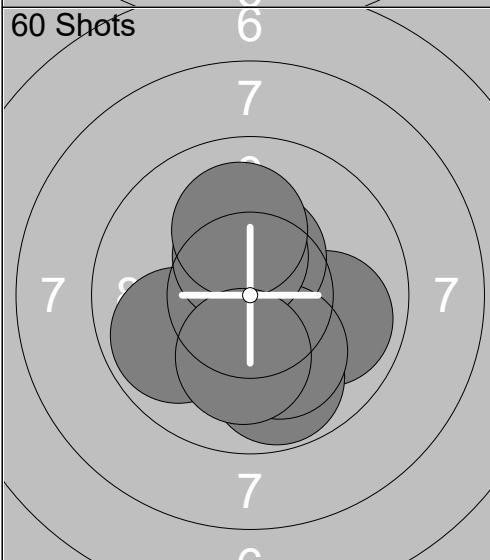
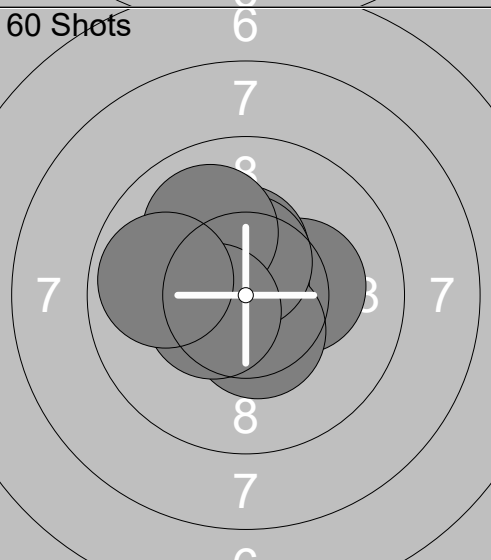
<p>60 Shots</p> 	<p>1: 10.0 ← 2: 10.0 → 3: 10.1 ↖ 4: 10.4x ↑ 5: 10.5x ← 6: 10.7x ↗ 7: 10.4x ↓ 8: 9.5 ← 9: 10.2x ← 10: 10.2x ↗</p> <p>Series 102.0 102.0</p>	<p>60 Shots</p> 	<p>11: 10.4x ← 12: 10.5x ↗ 13: 10.6x ← 14: 10.7x ← 15: 10.8x ↗ 16: 10.5x ↓ 17: 10.4x ← 18: 10.3x ↓ 19: 10.0 ↓ 20: 10.4x ↖</p> <p>Series 104.6 206.6</p>
<p>60 Shots</p> 	<p>21: 10.9x ↗ 22: 10.5x ↑ 23: 10.5x ↖ 24: 10.1 ↓ 25: 10.2x ↑ 26: 10.5x ↙ 27: 10.2x → 28: 10.4x → 29: 10.4x → 30: 9.7 →</p> <p>Series 103.4 310.0</p>	<p>60 Shots</p> 	<p>31: 9.9 ↗ 32: 10.3x ↘ 33: 10.2x ↙ 34: 10.8x ↖ 35: 10.2x ↗ 36: 10.0 ← 37: 9.8 ← 38: 10.4x ↑ 39: 9.9 ↑ 40: 10.4x ↙</p> <p>Series 101.9 411.9</p>
<p>60 Shots</p> 	<p>41: 10.4x ↓ 42: 10.5x → 43: 9.9 → 44: 9.8 ↓ 45: 9.9 ← 46: 10.4x ↑ 47: 10.1 ↓ 48: 10.4x ↑ 49: 10.1 ↑ 50: 10.1 ↓</p> <p>Series 101.6 513.5</p>	<p>60 Shots</p> 	<p>51: 10.3x → 52: 10.0 ← 53: 10.8x ↑ 54: 10.5x ↓ 55: 10.4x ↑ 56: 10.3x ← 57: 10.5x ↑ 58: 10.0 ↖ 59: 10.5x ← 60: 9.9 ←</p> <p>Series 103.2 616.7</p>

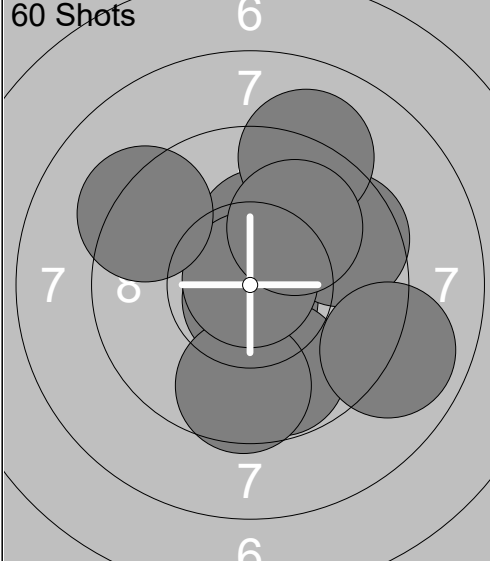
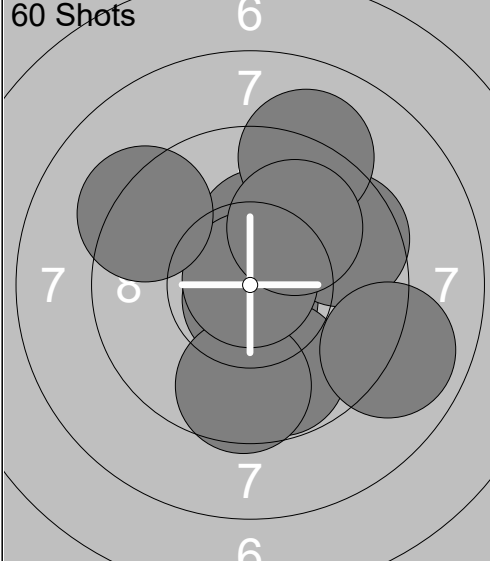
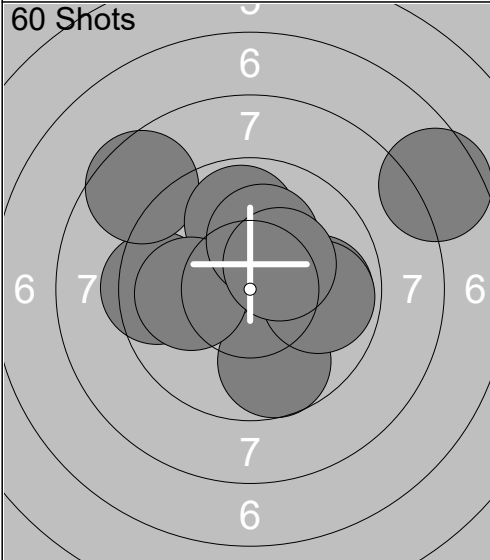
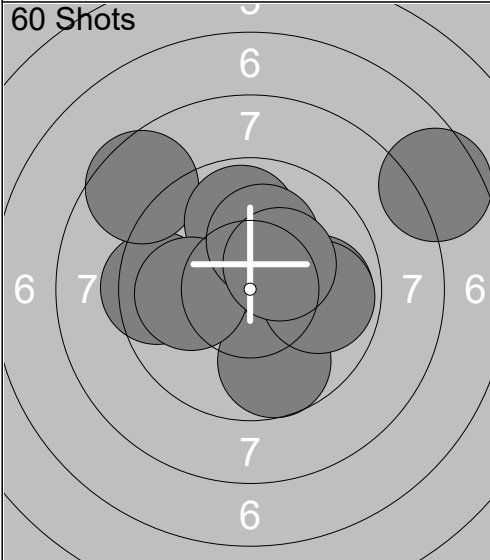
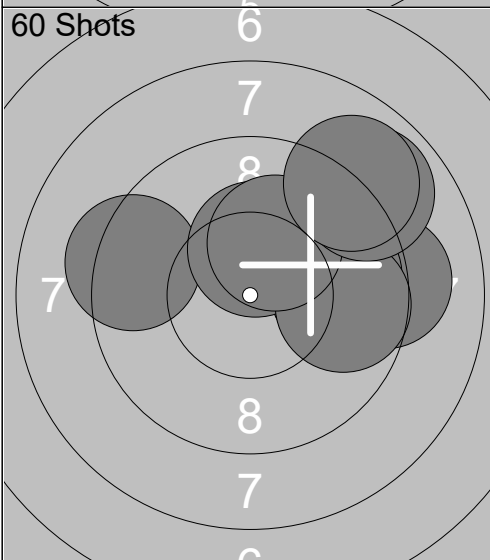
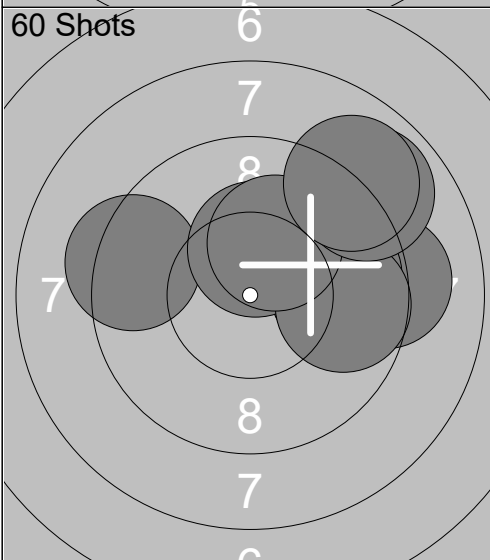
<p>60 Shots</p>  <p style="text-align: center;">6 7 7 7 7</p>	<p>1: 10.8x ↓ 2: 10.3x ↑ 3: 9.6 → 4: 9.8 ↓ 5: 9.6 ↓ 6: 10.9x ↑ 7: 9.3 ↖ 8: 8.9 → 9: 9.1 ↑ 10: 10.0 ↗</p> <p>Series 98.3 98.3</p>	<p>60 Shots</p>  <p style="text-align: center;">6 7 7 8 7</p>	<p>11: 10.0 ↖ 12: 9.8 → 13: 8.8 ↑ 14: 9.4 ↘ 15: 9.4 ↖ 16: 10.4x ↑ 17: 10.6x ↘ 18: 9.8 ← 19: 10.4x ↙ 20: 9.9 ↑</p> <p>Series 98.5 196.8</p>
<p>60 Shots</p>  <p style="text-align: center;">6 6 7 7 6 7 6</p>	<p>21: 9.5 ← 22: 9.7 ↓ 23: 8.6 ↗ 24: 9.9 → 25: 9.9 ↑ 26: 9.9 → 27: 7.6 → 28: 10.0 ← 29: 10.1 ↑ 30: 10.3x ↗</p> <p>Series 95.5 292.3</p>	<p>60 Shots</p>  <p style="text-align: center;">6 6 7 7 8 7</p>	<p>31: 10.4x ↖ 32: 10.4x → 33: 9.8 ↖ 34: 10.4x ↖ 35: 10.1 ↖ 36: 10.1 ↑ 37: 9.0 ↑ 38: 10.3x ↘ 39: 8.7 → 40: 9.5 ↖</p> <p>Series 98.7 391.0</p>
<p>60 Shots</p>  <p style="text-align: center;">6 7 8 7 8 7 6</p>	<p>41: 9.8 → 42: 9.7 → 43: 9.3 ← 44: 9.2 → 45: 9.8 → 46: 10.3x ↑ 47: 9.7 → 48: 10.2x ↑ 49: 8.9 ↗ 50: 9.0 ↗</p> <p>Series 95.9 486.9</p>	<p>60 Shots</p>  <p style="text-align: center;">6 6 7 6 8 7 6 5</p>	<p>51: 10.4x ↑ 52: 10.0 → 53: 10.6x → 54: 10.4x ↖ 55: 8.9 ↗ 56: 9.0 ↑ 57: 7.8 → 58: 10.3x ↑ 59: 9.6 ↖ 60: 9.7 ←</p> <p>Series 96.7 583.6</p>

Relay 6	Lane 10	Zach Brenner
--------------------------	--------------------------	---------------------

WVU Mobile Range		
------------------	--	--

18.11.2023	Walther Cup 2023	West Virginia University
------------	------------------	--------------------------

Comment	Signature
---------	-----------

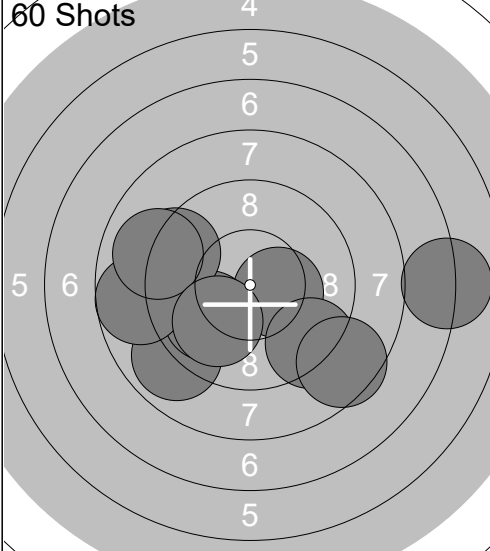
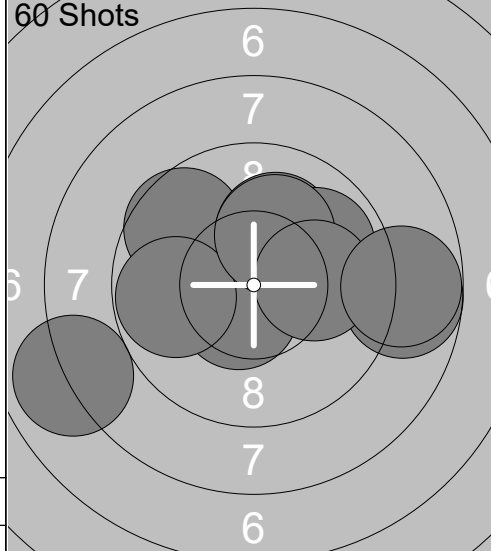
<p>60 Shots</p> 	<p>1: 10.4x →</p> <p>2: 8.9 ↙</p> <p>3: 9.3 ↘</p> <p>4: 8.6 ↘</p> <p>5: 9.9 ↙</p> <p>6: 9.3 ↗</p> <p>7: 8.7 ←</p> <p>8: 9.0 ↖</p> <p>9: 7.0 →</p> <p>10: 10.0 ↘</p> <p>Series 91.1</p> <p>91.1</p>	<p>60 Shots</p> 	<p>11: 9.6 ↖</p> <p>12: 10.5x ↘</p> <p>13: 10.1 ↗</p> <p>14: 9.9 ↗</p> <p>15: 8.0 ↙</p> <p>16: 9.8 ←</p> <p>17: 10.1 ↗</p> <p>18: 8.7 →</p> <p>19: 10.1 →</p> <p>20: 8.8 →</p> <p>Series 95.6</p> <p>186.7</p>
--	--	--	--

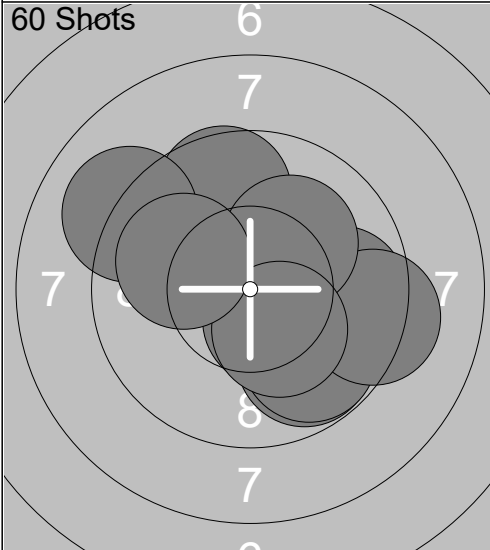
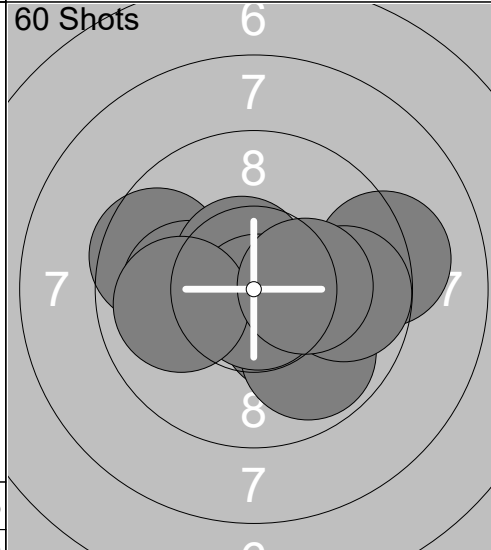
<p>60 Shots</p> 	<p>21: 9.8 ↘</p> <p>22: 9.8 →</p> <p>23: 10.5x ↘</p> <p>24: 9.8 ↘</p> <p>25: 9.6 ↗</p> <p>26: 9.3 →</p> <p>27: 10.1 ↗</p> <p>28: 9.1 ↗</p> <p>29: 10.3x ↘</p> <p>30: 10.0 ↖</p> <p>Series 98.3</p> <p>285.0</p>	<p>60 Shots</p> 	<p>31: 10.3x ↘</p> <p>32: 9.2 →</p> <p>33: 9.9 ↘</p> <p>34: 9.6 ↖</p> <p>35: 10.1 ←</p> <p>36: 10.6x ↗</p> <p>37: 10.8x ↘</p> <p>38: 10.0 ←</p> <p>39: 9.8 →</p> <p>40: 10.3x →</p> <p>Series 100.6</p> <p>385.6</p>
---	---	---	--

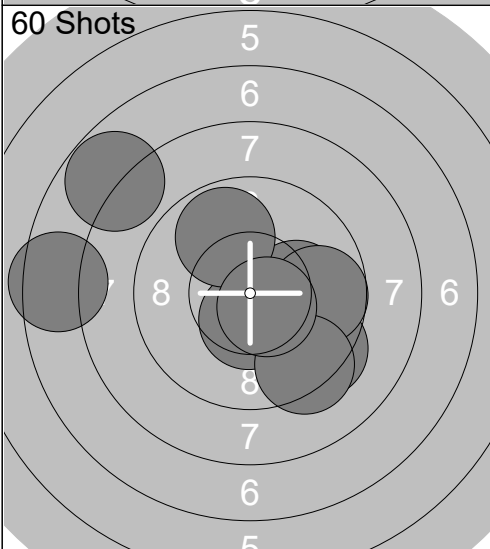
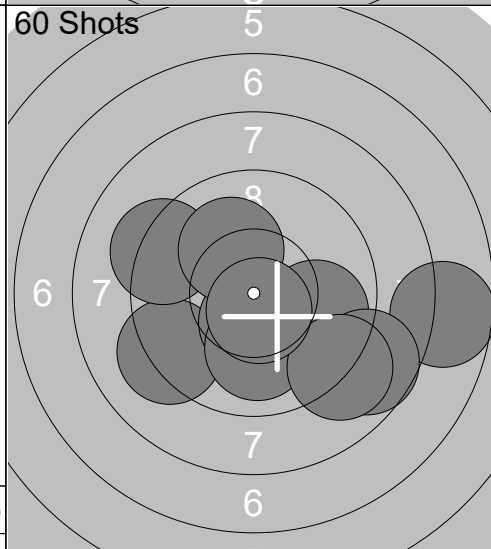
<p>60 Shots</p> 	<p>41: 9.9 →</p> <p>42: 10.1 →</p> <p>43: 9.4 ↘</p> <p>44: 7.5 ←</p> <p>45: 7.8 ↗</p> <p>46: 10.5x ↘</p> <p>47: 9.8 ↗</p> <p>48: 9.7 →</p> <p>49: 9.3 ↘</p> <p>50: 10.6x ↘</p> <p>Series 94.6</p> <p>480.2</p>	<p>60 Shots</p> 	<p>51: 7.7 →</p> <p>52: 9.2 ↙</p> <p>53: 9.8 →</p> <p>54: 9.2 ↖</p> <p>55: 10.5x ↘</p> <p>56: 10.0 ↘</p> <p>57: 10.1 ↗</p> <p>58: 8.7 ↘</p> <p>59: 9.0 ↘</p> <p>60: 10.6x ↘</p> <p>Series 94.8</p> <p>575.0</p>
--	--	--	---

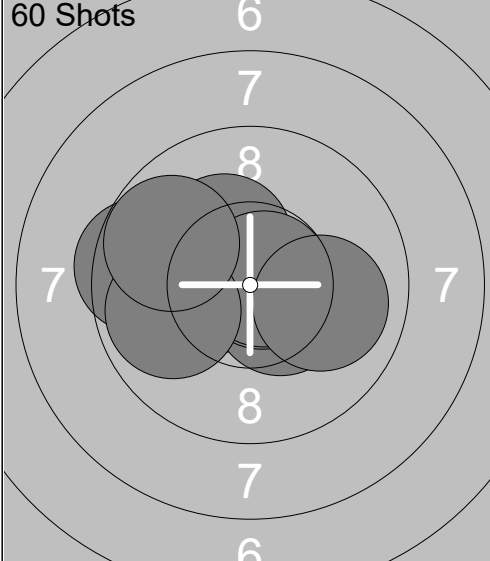
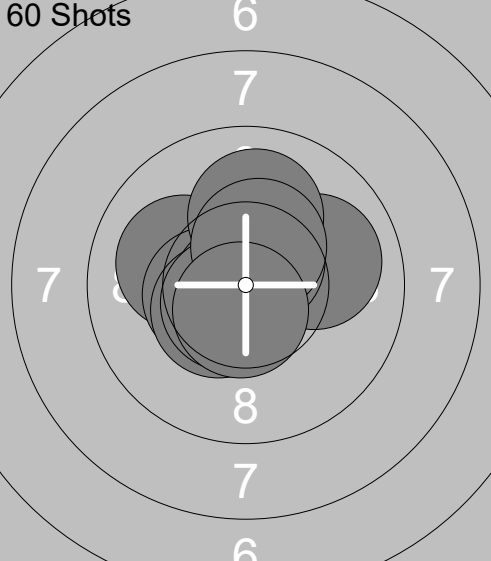
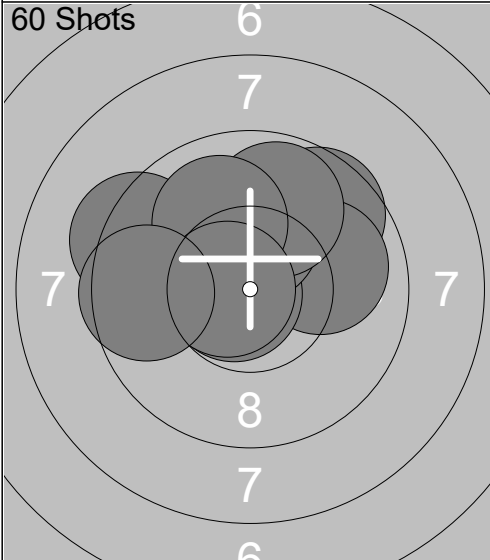
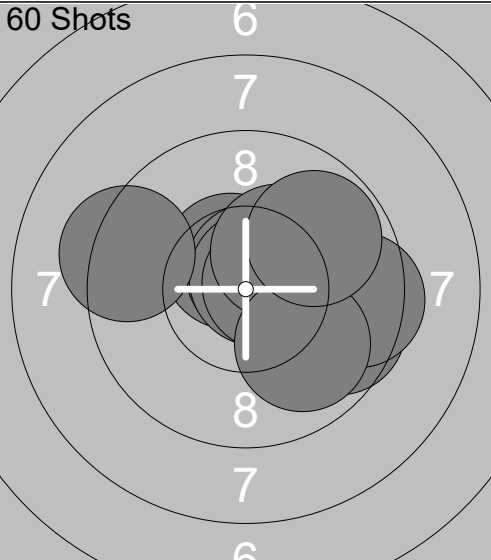
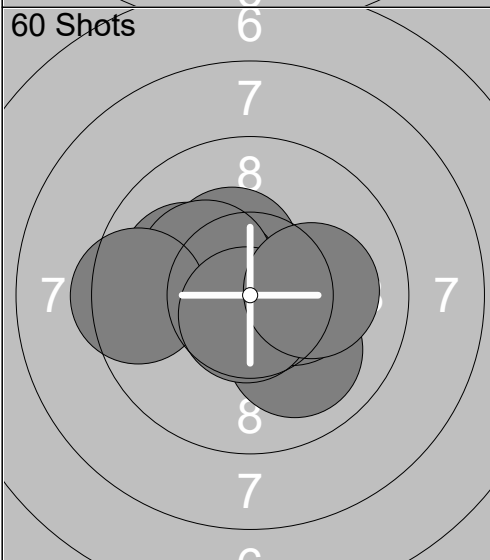
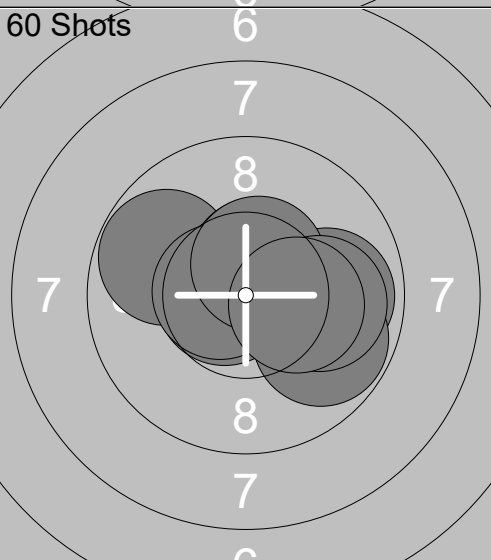
<p>60 Shots</p> 	<p>1: 10.2x ↗ 2: 10.3x ← 3: 10.4x ↘ 4: 9.5 ← 5: 10.3x ↗ 6: 10.8x → 7: 10.8x → 8: 9.9 ← 9: 10.0 → 10: 9.8 ↖</p> <p>Series 102.0 102.0</p>	<p>60 Shots</p> 	<p>11: 10.0 → 12: 10.1 ↖ 13: 10.5x ← 14: 10.9x ↙ 15: 10.6x ↗ 16: 10.5x ↙ 17: 10.6x ↙ 18: 10.0 ↑ 19: 10.4x ↑ 20: 10.6x ↓</p> <p>Series 104.2 206.2</p>
<p>60 Shots</p> 	<p>21: 9.3 ↖ 22: 10.5x ↖ 23: 9.6 ↗ 24: 10.0 → 25: 10.7x ← 26: 10.2x ↑ 27: 9.8 ↑ 28: 10.0 ↑ 29: 10.6x ← 30: 9.6 ←</p> <p>Series 100.3 306.5</p>	<p>60 Shots</p> 	<p>31: 9.6 → 32: 10.5x ↖ 33: 10.7x ↑ 34: 10.7x ↗ 35: 9.5 → 36: 9.3 ↖ 37: 10.6x → 38: 10.3x ↗ 39: 9.9 ↘ 40: 9.8 ↗</p> <p>Series 100.9 407.4</p>
<p>60 Shots</p> 	<p>41: 10.8x ↖ 42: 10.0 ↘ 43: 10.1 ↖ 44: 10.4x → 45: 10.4x ↗ 46: 10.5x ↖ 47: 10.3x ↖ 48: 9.5 ← 49: 10.7x ↓ 50: 10.1 →</p> <p>Series 102.8 510.2</p>	<p>60 Shots</p> 	<p>51: 9.9 → 52: 9.8 ↖ 53: 10.8x ↗ 54: 10.5x ↑ 55: 10.7x ← 56: 10.6x ← 57: 9.8 ↘ 58: 10.5x ↑ 59: 10.0 → 60: 10.3x →</p> <p>Series 102.9 613.1</p>

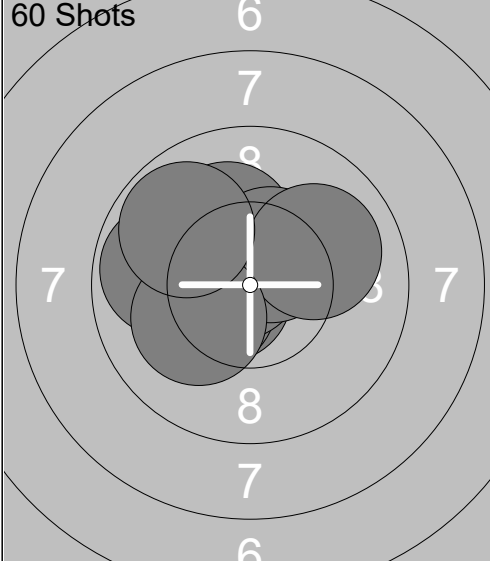
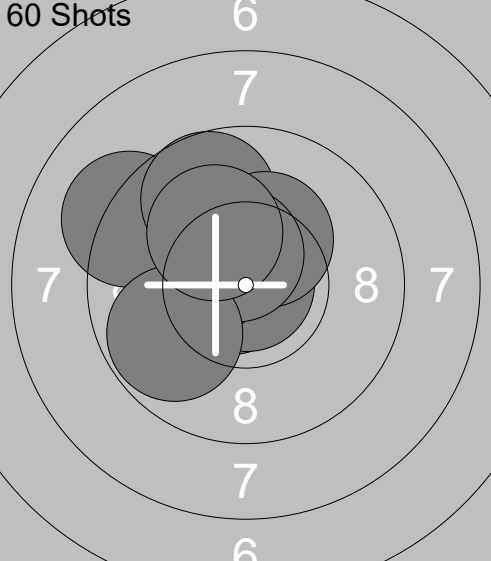
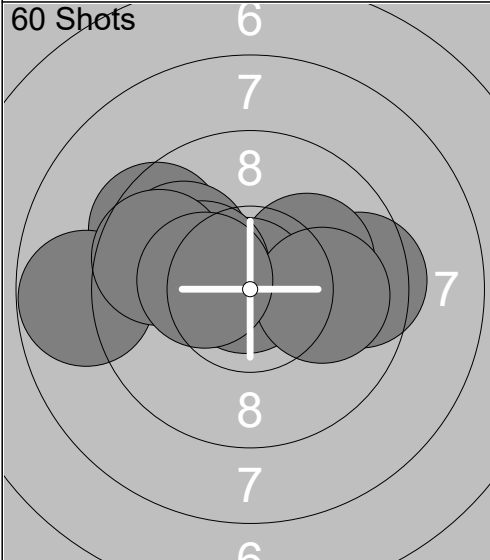
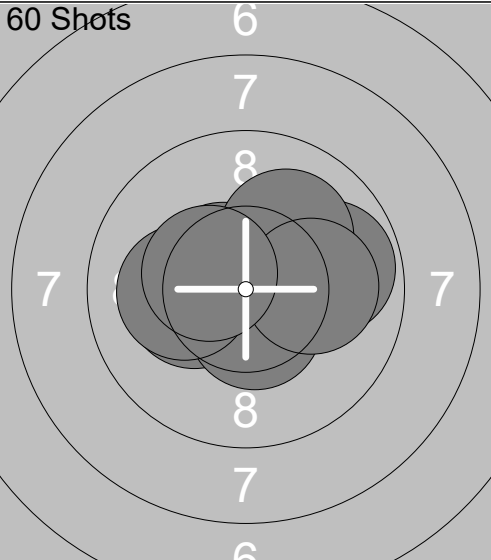
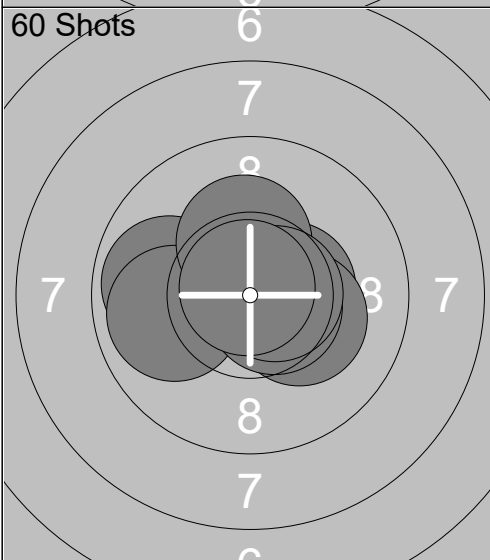
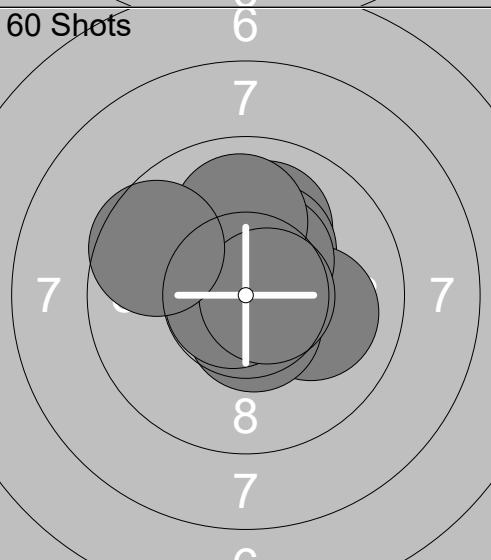
<p>60 Shots</p> 	<p>1: 10.2x ↗ 2: 10.6x ← 3: 10.3x ← 4: 10.2x ← 5: 10.7x ↖ 6: 10.5x ↗ 7: 9.8 ← 8: 10.0 → 9: 10.1 ← 10: 9.8 ↖</p> <p>Series 102.2 102.2</p>	<p>60 Shots</p> 	<p>11: 10.8x ← 12: 10.3x ↖ 13: 10.9x ↗ 14: 10.3x ← 15: 9.2 ↖ 16: 9.7 ↗ 17: 10.3x ↗ 18: 10.5x ↗ 19: 9.8 ← 20: 10.1 ↖</p> <p>Series 101.9 204.1</p>
<p>60 Shots</p> 	<p>21: 9.5 → 22: 9.5 ↖ 23: 9.9 ↖ 24: 10.1 → 25: 10.9x ↖ 26: 10.3x ← 27: 8.8 ← 28: 10.0 → 29: 9.7 ↖ 30: 10.3x ←</p> <p>Series 99.0 303.1</p>	<p>60 Shots</p> 	<p>31: 10.3x → 32: 10.6x ↖ 33: 9.8 → 34: 10.5x ↗ 35: 10.3x ← 36: 10.5x ↓ 37: 10.1 ↗ 38: 10.1 → 39: 10.1 ← 40: 10.4x ↖</p> <p>Series 102.7 405.8</p>
<p>60 Shots</p> 	<p>41: 10.7x → 42: 10.8x ↗ 43: 10.4x → 44: 9.9 ← 45: 9.9 ← 46: 10.3x ↗ 47: 10.2x → 48: 10.6x → 49: 10.6x → 50: 10.8x ↗</p> <p>Series 104.2 510.0</p>	<p>60 Shots</p> 	<p>51: 10.0 ↗ 52: 10.3x ↗ 53: 10.1 → 54: 10.6x ↓ 55: 10.1 ↖ 56: 10.4x ↗ 57: 10.8x ← 58: 10.0 ↗ 59: 10.7x → 60: 9.6 ↖</p> <p>Series 102.6 612.6</p>

<p>60 Shots</p>	<p>1: 9.8 → 2: 10.3x → 3: 10.4x ↑ 4: 9.9 ↑ 5: 9.7 → 6: 9.9 ↗ 7: 10.1 ← 8: 10.6x ↓ 9: 10.4x ↖ 10: 10.1 ↙</p> <p>Series 101.2 101.2</p>	<p>60 Shots</p>	<p>11: 10.6x ↓ 12: 10.3x → 13: 10.1 ← 14: 10.5x ↖ 15: 9.2 ← 16: 10.5x ↑ 17: 10.0 ← 18: 10.0 → 19: 10.7x ↙ 20: 10.6x ↘</p> <p>Series 102.5 203.7</p>
<p>60 Shots</p>	<p>21: 10.4x ↓ 22: 10.3x ↙ 23: 10.0 → 24: 10.3x ↙ 25: 9.5 ↑ 26: 10.1 → 27: 10.4x ↓ 28: 10.1 ↓ 29: 10.6x ↑ 30: 10.1 ↘</p> <p>Series 101.8 305.5</p>	<p>60 Shots</p>	<p>31: 10.7x ← 32: 9.2 → 33: 10.0 ← 34: 10.5x ↖ 35: 10.8x ↑ 36: 10.6x ↖ 37: 8.9 ↘ 38: 10.8x ↓ 39: 10.4x ↖ 40: 10.6x ↓</p> <p>Series 102.5 408.0</p>
<p>60 Shots</p>	<p>41: 9.5 → 42: 10.1 ← 43: 8.7 ↘ 44: 10.4x ↓ 45: 10.3x → 46: 10.2x ↓ 47: 10.0 ← 48: 10.7x ↑ 49: 10.3x ↓ 50: 10.3x ↙</p> <p>Series 100.5 508.5</p>	<p>60 Shots</p>	<p>51: 9.0 ↘ 52: 10.4x ↓ 53: 10.2x ↓ 54: 9.4 ↘ 55: 9.7 → 56: 9.6 ↘ 57: 10.4x → 58: 10.4x → 59: 10.2x ↗ 60: 10.2x ↘</p> <p>Series 99.5 608.0</p>

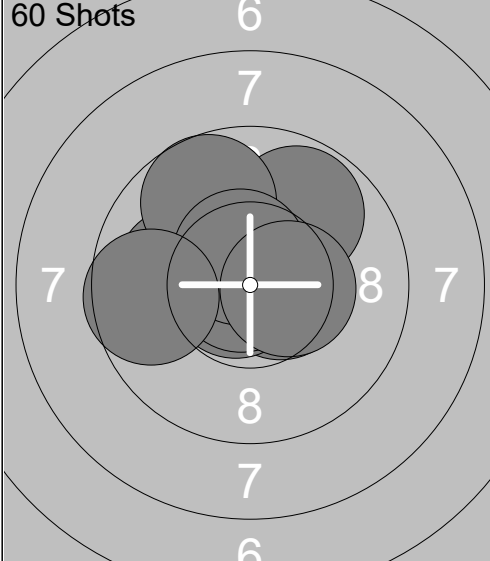
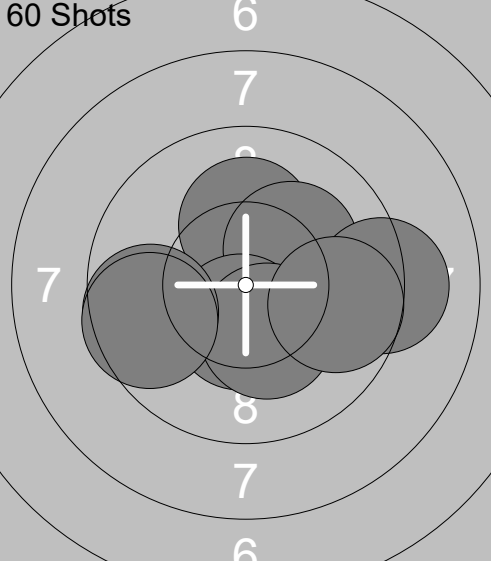
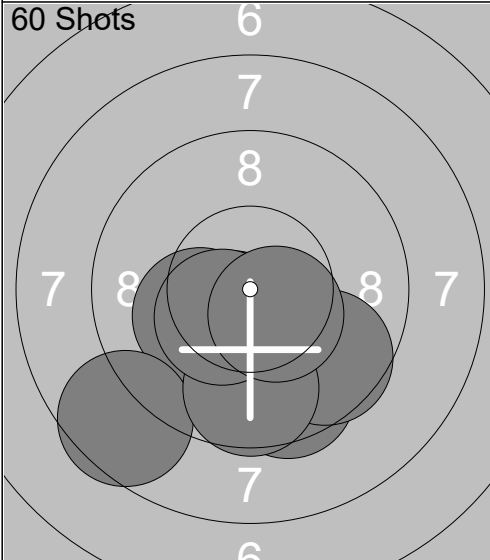
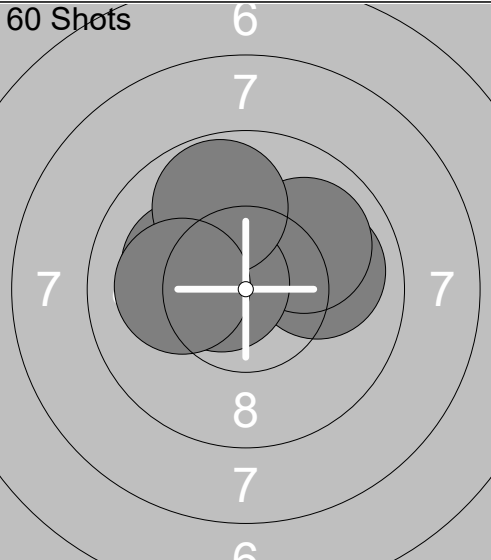
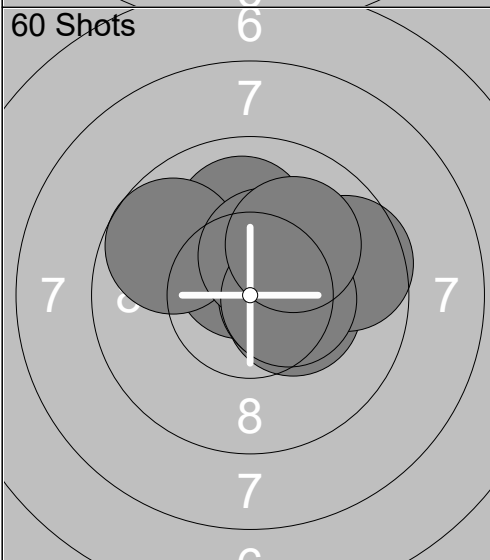
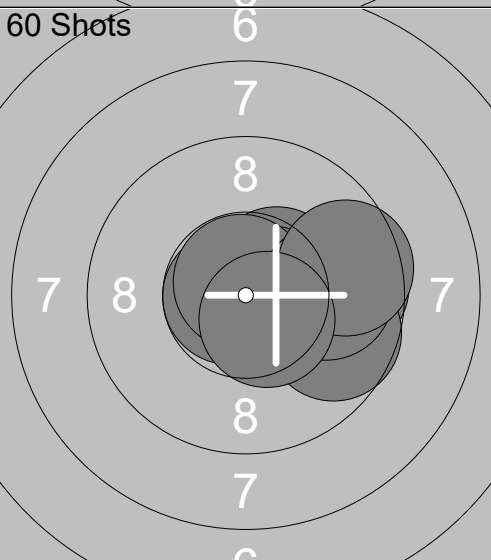
<p>60 Shots</p> 	<p>1: 10.1 ←</p> <p>2: 10.5x →</p> <p>3: 10.8x →</p> <p>4: 9.8 ↗</p> <p>5: 9.7 ↗</p> <p>6: 10.8x ←</p> <p>7: 10.8x ←</p> <p>8: 10.6x ↗</p> <p>9: 9.6 ←</p> <p>10: 10.4x →</p> <p>Series 103.1</p> <p style="text-align: center;">103.1</p>	<p>60 Shots</p> 	<p>11: 10.3x ↗</p> <p>12: 10.6x ↘</p> <p>13: 10.2x ↑</p> <p>14: 10.2x ↗</p> <p>15: 10.5x ↓</p> <p>16: 9.2 →</p> <p>17: 10.3x ↓</p> <p>18: 9.6 ←</p> <p>19: 9.7 →</p> <p>20: 9.6 ←</p> <p>Series 100.2</p> <p style="text-align: center;">203.3</p>
<p>60 Shots</p> 	<p>21: 10.5x ↓</p> <p>22: 10.3x ↓</p> <p>23: 9.9 ↓</p> <p>24: 9.5 ↓</p> <p>25: 9.6 ↓</p> <p>26: 10.2x ←</p> <p>27: 8.6 ↓</p> <p>28: 9.6 ↓</p> <p>29: 10.4x ↓</p> <p>30: 10.5x ↓</p> <p>Series 99.1</p> <p style="text-align: center;">302.4</p>	<p>60 Shots</p> 	<p>31: 10.4x ←</p> <p>32: 10.3x ↑</p> <p>33: 10.0 →</p> <p>34: 10.1 ←</p> <p>35: 10.2x ↑</p> <p>36: 10.4x ←</p> <p>37: 10.0 ↗</p> <p>38: 10.6x ←</p> <p>39: 9.8 ↑</p> <p>40: 10.1 ←</p> <p>Series 101.9</p> <p style="text-align: center;">404.3</p>
<p>60 Shots</p> 	<p>41: 10.3x ↗</p> <p>42: 10.0 ↑</p> <p>43: 10.6x ↗</p> <p>44: 9.7 ↖</p> <p>45: 10.3x →</p> <p>46: 10.5x →</p> <p>47: 9.6 →</p> <p>48: 10.4x ↗</p> <p>49: 10.4x →</p> <p>50: 10.1 ↗</p> <p>Series 101.9</p> <p style="text-align: center;">506.2</p>	<p>60 Shots</p> 	<p>51: 10.7x ←</p> <p>52: 9.7 →</p> <p>53: 10.6x →</p> <p>54: 10.5x ↗</p> <p>55: 9.7 →</p> <p>56: 10.6x →</p> <p>57: 10.8x ↑</p> <p>58: 9.9 →</p> <p>59: 9.6 →</p> <p>60: 10.5x ↓</p> <p>Series 102.6</p> <p style="text-align: center;">608.8</p>

Relay 6	Lane 15	Addison Antwiler
-------------------	-------------------	-------------------------

WVU Mobile Range			
------------------	--	--	--

18.11.2023	Walther Cup 2023	West Virginia University
------------	------------------	--------------------------

Comment	Signature
---------	-----------

<p>60 Shots</p>	<p>1: 9.1 ↖ 2: 10.4x → 3: 10.0 ↗ 4: 10.4x → 5: 10.9x ↓ 6: 10.8x ↖ 7: 10.6x ↙ 8: 10.4x → 9: 10.3x ↓ 10: 10.2x ↑</p> <p>Series 103.1 103.1</p>	<p>60 Shots</p>	<p>11: 9.5 → 12: 10.2x ↓ 13: 10.5x ↑ 14: 9.5 → 15: 9.8 ↖ 16: 10.2x ↗ 17: 10.6x → 18: 10.6x ↑ 19: 10.5x ↓ 20: 10.2x ↑</p> <p>Series 101.6 204.7</p>
<p>60 Shots</p>	<p>21: 9.8 ↑ 22: 10.2x ↖ 23: 10.8x ↓ 24: 9.7 ↙ 25: 9.2 ← 26: 10.4x ↖ 27: 10.3x ↖ 28: 9.9 ↓ 29: 10.2x ↗ 30: 10.0 ↓</p> <p>Series 100.5 305.2</p>	<p>60 Shots</p>	<p>31: 9.9 ↙ 32: 10.6x ↗ 33: 10.6x → 34: 10.1 ← 35: 9.8 ↖ 36: 9.4 → 37: 10.5x ← 38: 9.7 → 39: 10.6x ↖ 40: 10.4x →</p> <p>Series 101.6 406.8</p>
<p>60 Shots</p>	<p>41: 10.1 → 42: 9.8 → 43: 9.1 ↑ 44: 10.1 ↑ 45: 10.1 ↗ 46: 9.9 → 47: 10.2x ↖ 48: 10.7x ↙ 49: 10.5x ↙ 50: 9.6 →</p> <p>Series 100.1 506.9</p>	<p>60 Shots</p>	<p>51: 10.2x ↑ 52: 10.3x ↓ 53: 10.1 ← 54: 9.7 ↖ 55: 9.7 ↗ 56: 10.8x ↗ 57: 10.0 ↑ 58: 10.5x ← 59: 10.6x ← 60: 10.5x ↖</p> <p>Series 102.4 609.3</p>

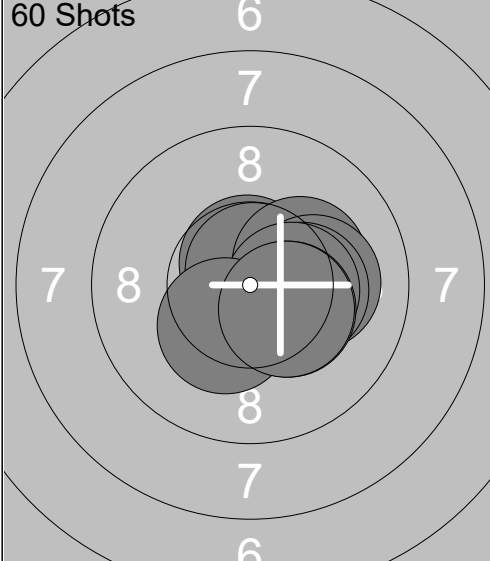
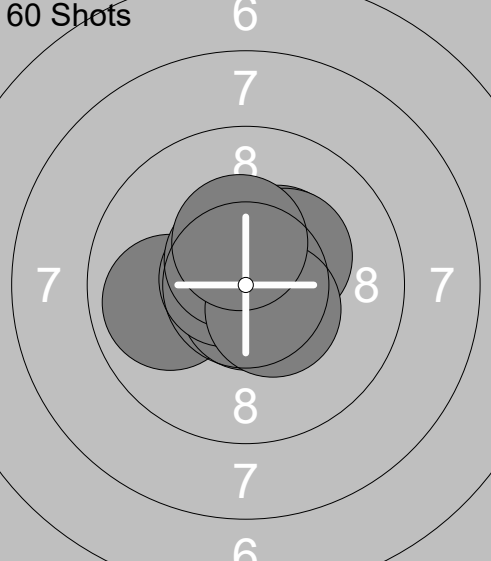
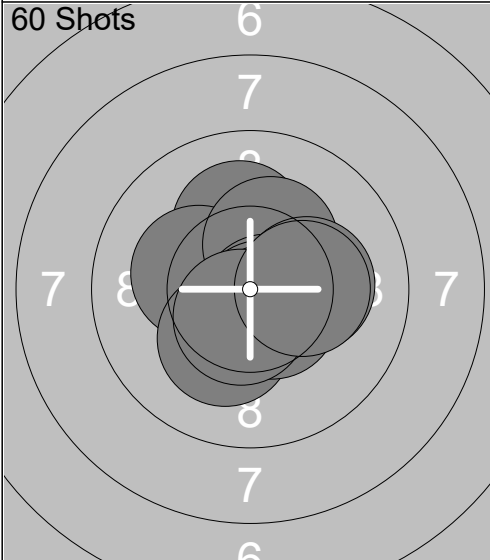
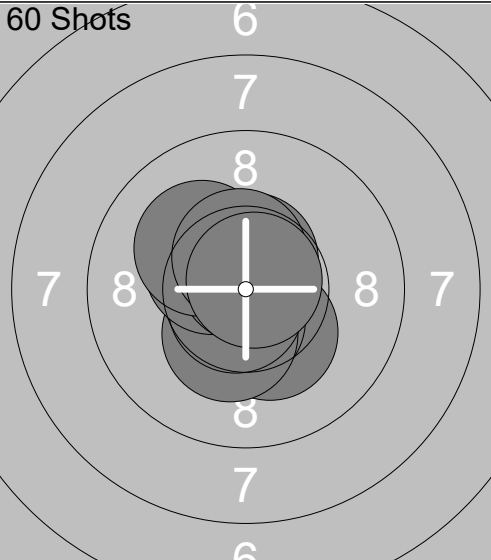
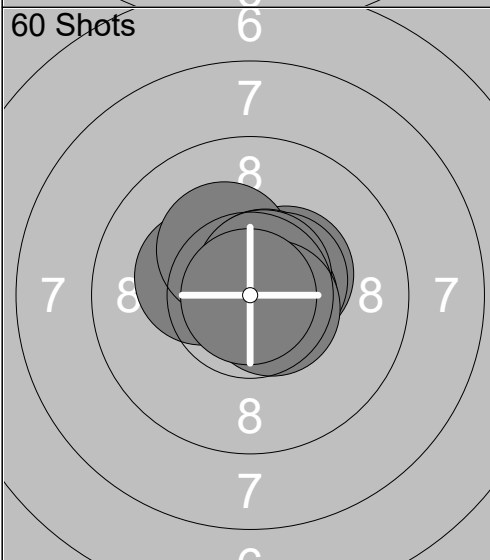
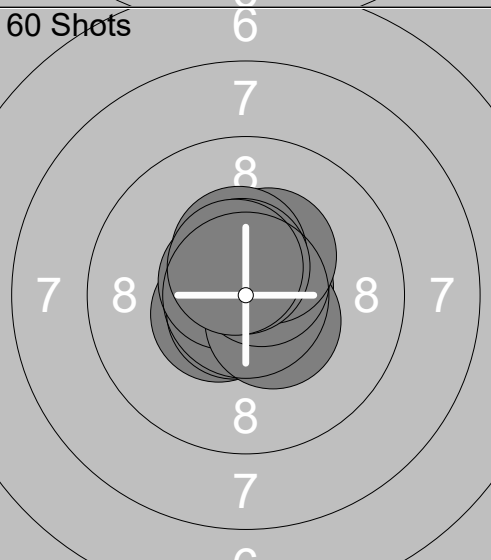
<p>60 Shots</p> 	<p>1: 10.7x ↑ 2: 10.8x ↑ 3: 10.3x → 4: 10.2x → 5: 10.1 → 6: 10.3x → 7: 10.4x → 8: 10.3x ↓ 9: 10.4x ↘ 10: 10.4x ↘</p> <p>Series 103.9 103.9</p>	<p>60 Shots</p> 	<p>11: 9.9 ← 12: 10.7x ↓ 13: 10.4x ↗ 14: 10.9x ↖ 15: 10.7x ↖ 16: 10.6x ↖ 17: 10.6x → 18: 10.3x ↗ 19: 10.5x ↘ 20: 10.4x ↑</p> <p>Series 105.0 208.9</p>
<p>60 Shots</p> 	<p>21: 10.1 ↑ 22: 10.2x ↖ 23: 10.3x ↑ 24: 10.7x ↘ 25: 10.2x ↓ 26: 10.7x ↓ 27: 10.5x ↓ 28: 10.2x → 29: 10.6x ↓ 30: 10.3x →</p> <p>Series 103.8 312.7</p>	<p>60 Shots</p> 	<p>31: 10.3x ↓ 32: 10.5x ↓ 33: 10.3x ↓ 34: 10.7x ↓ 35: 10.4x ↖ 36: 10.6x ↑ 37: 10.8x ↑ 38: 10.2x ↖ 39: 10.5x ↑ 40: 10.8x ↗</p> <p>Series 105.1 417.8</p>
<p>60 Shots</p> 	<p>41: 10.3x ↖ 42: 10.7x ↗ 43: 10.4x ↗ 44: 10.3x ↖ 45: 10.6x ↗ 46: 10.5x ↗ 47: 10.7x → 48: 10.7x ↗ 49: 10.6x ↘ 50: 10.9x ↓</p> <p>Series 105.7 523.5</p>	<p>60 Shots</p> 	<p>51: 10.5x ↖ 52: 10.7x ↓ 53: 10.7x → 54: 10.6x ↖ 55: 10.5x ↘ 56: 10.6x ↗ 57: 10.3x ↗ 58: 10.4x ↑ 59: 10.6x ↑ 60: 10.6x ↖</p> <p>Series 105.5 629.0</p>

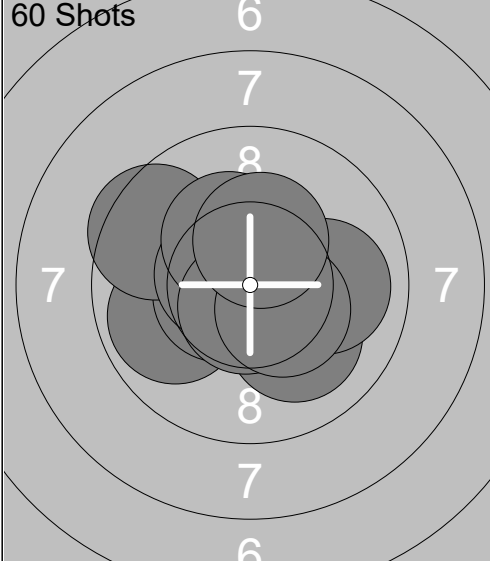
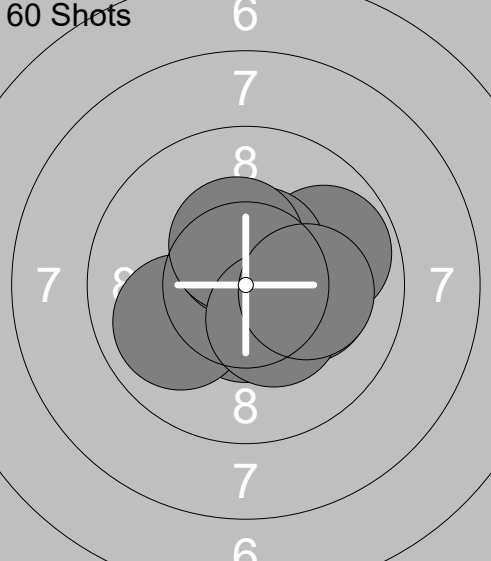
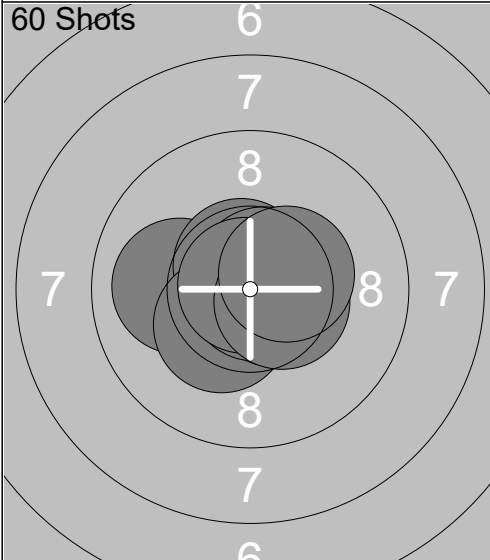
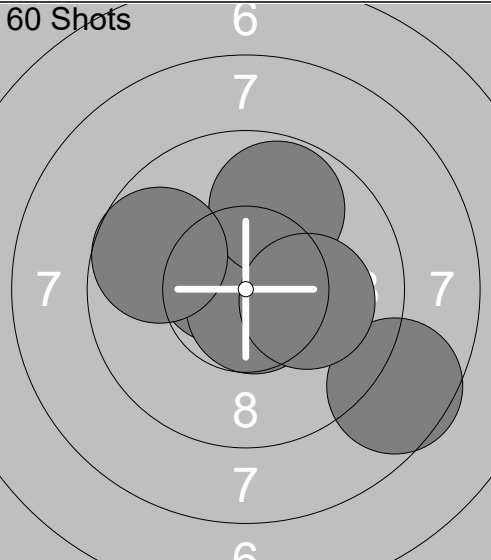
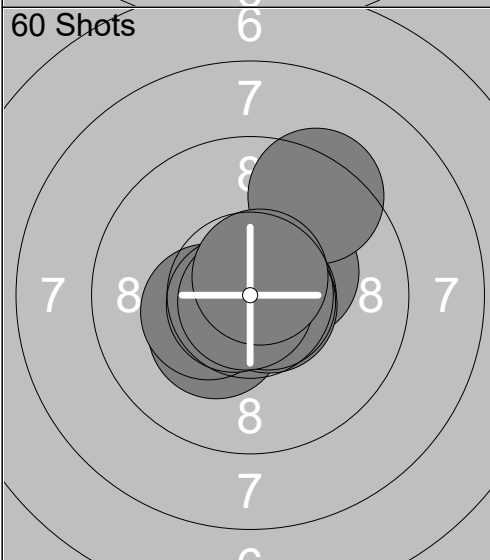
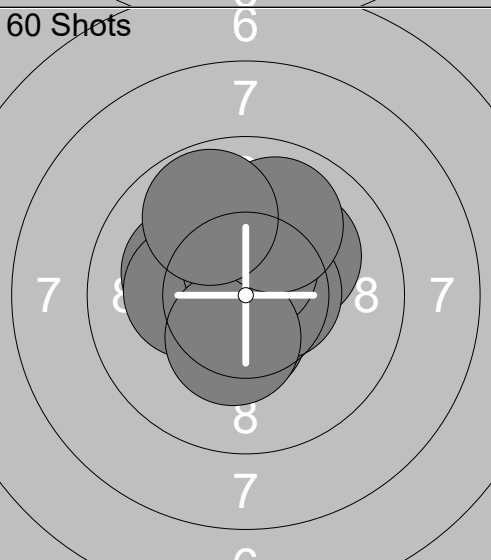
<p>60 Shots</p> 	<p>1: 10.1 ↘ 2: 9.9 ← 3: 10.5x ← 4: 9.5 ↖ 5: 10.6x ↖ 6: 10.0 → 7: 10.3x ↗ 8: 10.7x ↓ 9: 10.4x ↘ 10: 10.3x ↗</p> <p>Series 102.3 102.3</p>	<p>60 Shots</p> 	<p>11: 10.6x ↓ 12: 10.7x ↘ 13: 10.0 ← 14: 9.8 → 15: 10.2x → 16: 10.5x ↑ 17: 10.5x ↗ 18: 10.4x ↑ 19: 10.4x ↘ 20: 10.1 →</p> <p>Series 103.2 205.5</p>
<p>60 Shots</p> 	<p>21: 10.0 ← 22: 10.6x ↗ 23: 10.3x ↘ 24: 10.6x → 25: 10.9x ↘ 26: 10.8x → 27: 10.7x ↗ 28: 10.9x ↖ 29: 10.5x → 30: 10.4x →</p> <p>Series 105.7 311.2</p>	<p>60 Shots</p> 	<p>31: 10.6x ↖ 32: 10.7x ↑ 33: 10.6x ↗ 34: 10.5x ↗ 35: 8.6 ↘ 36: 10.5x → 37: 10.7x ↓ 38: 9.8 ↑ 39: 10.1 → 40: 9.7 ←</p> <p>Series 101.8 413.0</p>
<p>60 Shots</p> 	<p>41: 10.3x ↗ 42: 10.7x → 43: 9.4 ↗ 44: 10.3x ↘ 45: 10.4x ← 46: 10.7x ↖ 47: 10.7x ↘ 48: 10.7x → 49: 10.8x ↘ 50: 10.7x ↗</p> <p>Series 104.7 517.7</p>	<p>60 Shots</p> 	<p>51: 10.8x ↑ 52: 10.1 ↗ 53: 10.5x ↓ 54: 10.6x → 55: 10.1 ↖ 56: 10.2x ← 57: 10.6x ↑ 58: 10.4x ↓ 59: 9.9 ↗ 60: 9.8 ↖</p> <p>Series 103.0 620.7</p>

Relay 6	Lane 18	Mackenzie Pruden
-------------------	-------------------	-------------------------

WVU Mobile Range			
------------------	--	--	--

18.11.2023	Walther Cup 2023	West Virginia University
------------	------------------	--------------------------

Comment	Signature
---------	-----------

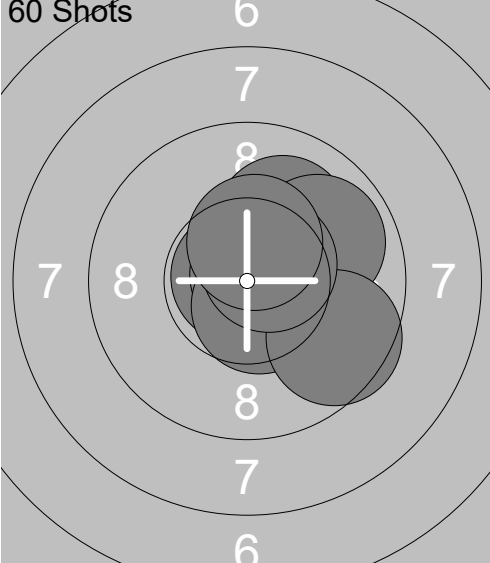
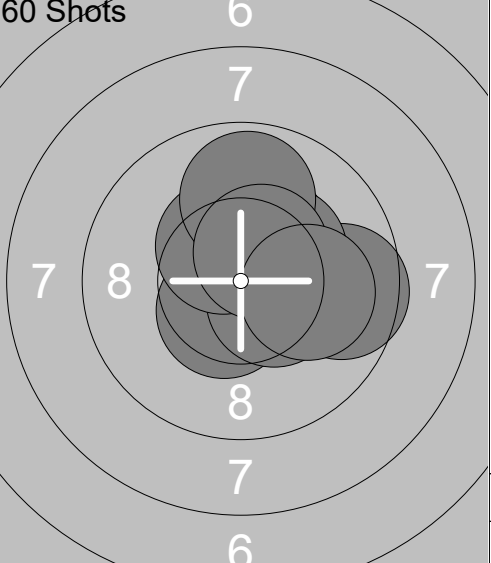
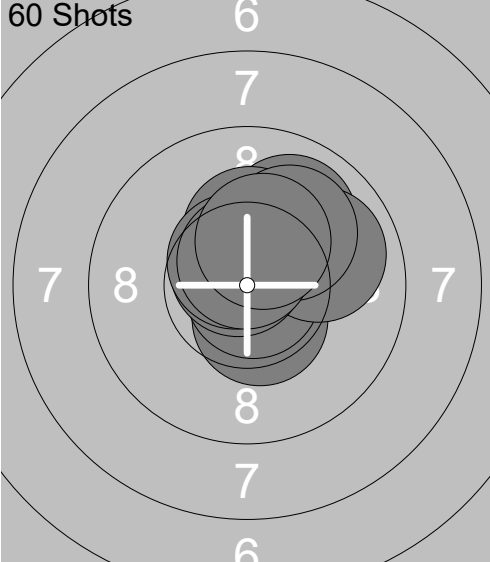
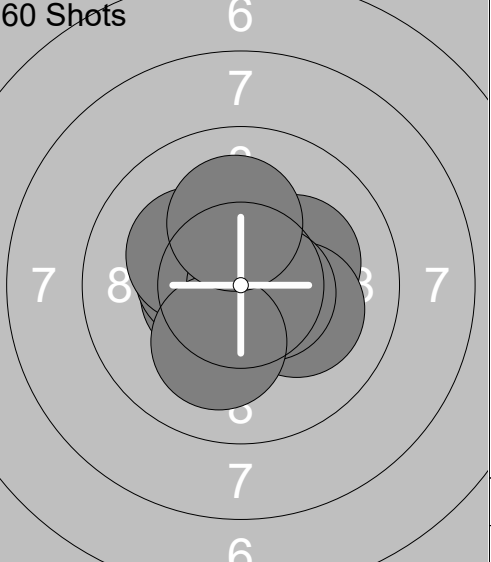
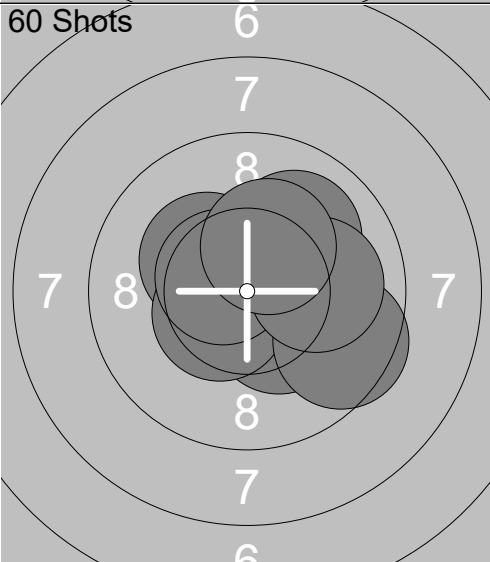
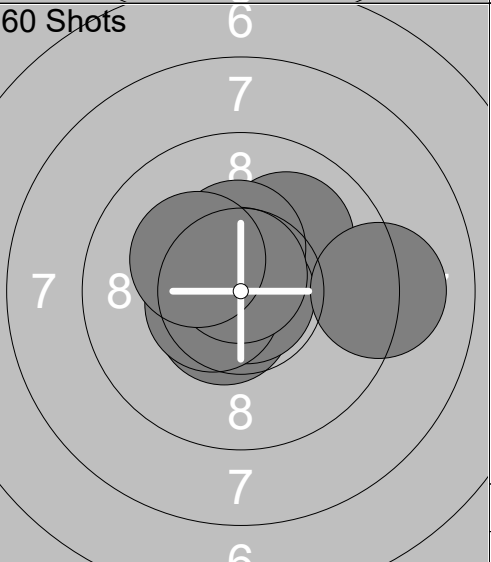
60 Shots 	1: 10.1 ↗ 2: 10.8x ↖ 3: 10.3x → 4: 10.6x ↘ 5: 10.8x ↗ 6: 10.6x ↘ 7: 9.9 → 8: 9.6 ↘ 9: 10.6x ↗ 10: 10.4x ↑	60 Shots 	11: 10.5x ↘ 12: 10.4x → 13: 9.6 → 14: 10.4x ↘ 15: 10.4x ↗ 16: 10.3x ↗ 17: 10.3x ↗ 18: 9.9 ↑ 19: 10.5x ↗ 20: 10.1 →
	Series 103.7		Series 102.4
	103.7		206.1
60 Shots 	21: 10.5x ↘ 22: 9.9 ↗ 23: 10.8x ↘ 24: 9.9 → 25: 10.3x ↑ 26: 10.1 ↗ 27: 10.7x ↗ 28: 10.6x ↗ 29: 10.6x ↑ 30: 10.3x ↑	60 Shots 	31: 10.2x → 32: 10.6x ↗ 33: 10.5x ← 34: 10.4x ← 35: 10.2x ↖ 36: 10.8x → 37: 10.1 ↘ 38: 10.6x → 39: 10.1 ↘ 40: 10.1 ↑
	Series 103.7		Series 103.6
	309.8		413.4
60 Shots 	41: 10.5x → 42: 10.3x ↖ 43: 10.4x ↗ 44: 10.3x ↘ 45: 10.5x ↖ 46: 10.0 ↗ 47: 9.5 ↘ 48: 10.6x ↖ 49: 10.0 → 50: 10.3x ↑	60 Shots 	51: 10.7x ↖ 52: 10.7x ↘ 53: 10.0 ↗ 54: 10.5x ↘ 55: 10.4x ↑ 56: 10.9x ↘ 57: 10.5x ← 58: 10.7x ↑ 59: 9.1 → 60: 10.2x ↖
	Series 102.4		Series 103.7
	515.8		619.5

<p>60 Shots</p>	<p>1: 9.5 ↗ 2: 10.2x ↖ 3: 9.3 ← 4: 9.9 ↙ 5: 10.3x ← 6: 9.4 ↗ 7: 10.3x → 8: 10.7x ↓ 9: 9.6 ← 10: 10.1 ←</p> <p>Series 99.3 99.3</p>	<p>60 Shots</p>	<p>11: 9.8 → 12: 10.3x → 13: 9.4 ← 14: 9.3 ← 15: 10.8x → 16: 10.6x ↙ 17: 8.7 ↗ 18: 9.6 ↗ 19: 10.1 ↖ 20: 9.8 ↗</p> <p>Series 98.4 197.7</p>
<p>60 Shots</p>	<p>21: 10.1 ↓ 22: 10.1 ↓ 23: 10.3x ↑ 24: 10.5x ↖ 25: 10.4x ↗ 26: 9.2 → 27: 9.2 ↗ 28: 9.9 ↑ 29: 10.4x ← 30: 10.2x ↑</p> <p>Series 100.3 298.0</p>	<p>60 Shots</p>	<p>31: 9.8 ↗ 32: 9.7 ⇒ 33: 10.0 → 34: 10.2x ↖ 35: 10.4x ↖ 36: 10.5x ← 37: 10.7x ↑ 38: 9.6 ← 39: 9.8 ↗ 40: 10.6x ↖</p> <p>Series 101.3 399.3</p>
<p>60 Shots</p>	<p>41: 10.2x ↑ 42: 10.4x ↖ 43: 9.8 ↗ 44: 10.0 ↓ 45: 10.3x ↓ 46: 9.6 ↖ 47: 10.5x ↑ 48: 10.1 ↗ 49: 9.9 ↙ 50: 10.4x ←</p> <p>Series 101.2 500.5</p>	<p>60 Shots</p>	<p>51: 9.9 ↗ 52: 9.2 ↙ 53: 10.1 ← 54: 10.8x ↓ 55: 9.7 ↙ 56: 10.6x ↓ 57: 10.1 ↖ 58: 10.8x ↙ 59: 10.5x ↓ 60: 10.1 ←</p> <p>Series 101.8 602.3</p>

Relay 6	Lane 20	Molly Miller
-------------------	-------------------	---------------------

WVU Mobile Range			
------------------	--	--	--

18.11.2023	Walther Cup 2023	West Virginia University
------------	------------------	--------------------------

Comment	Signature
---------	-----------

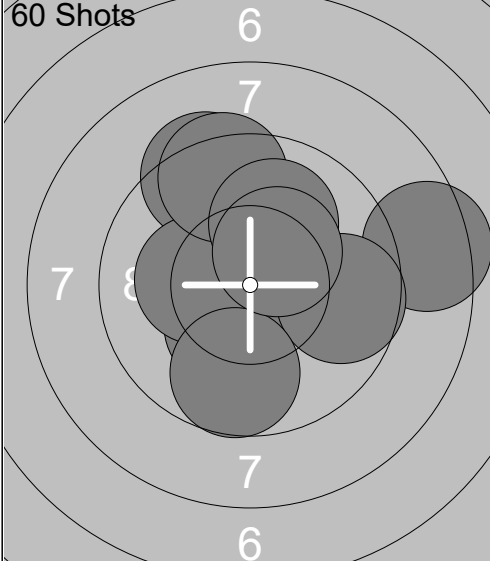
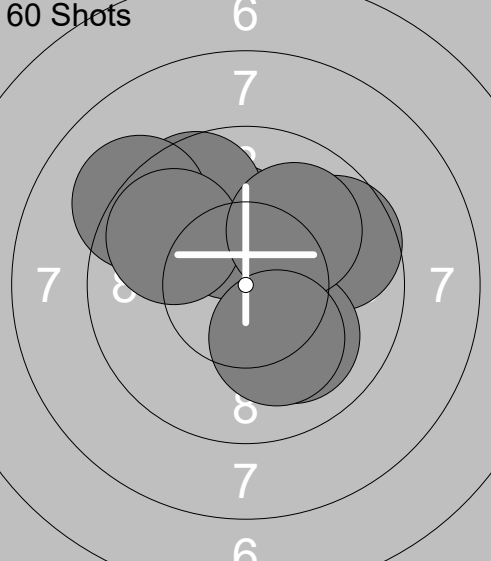
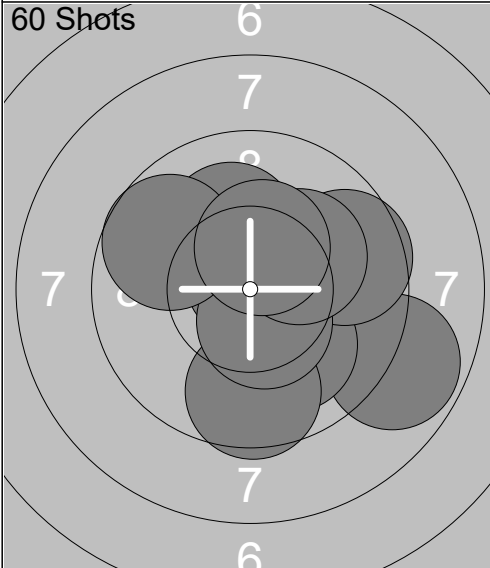
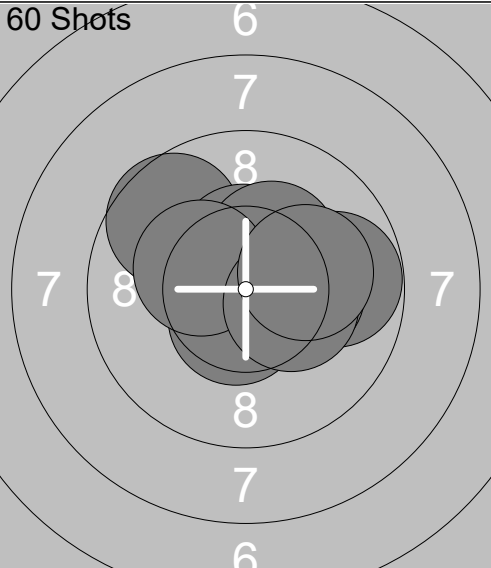
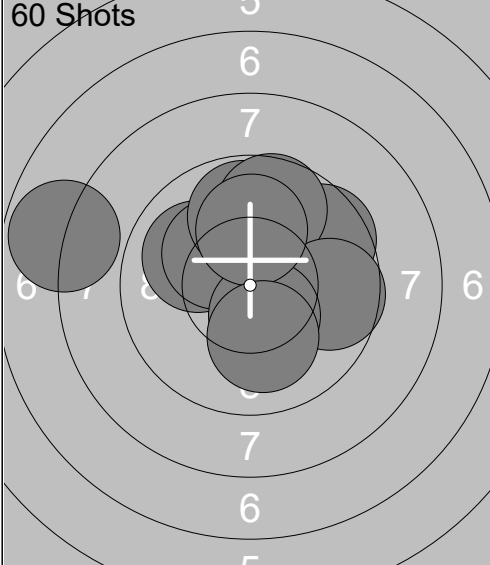
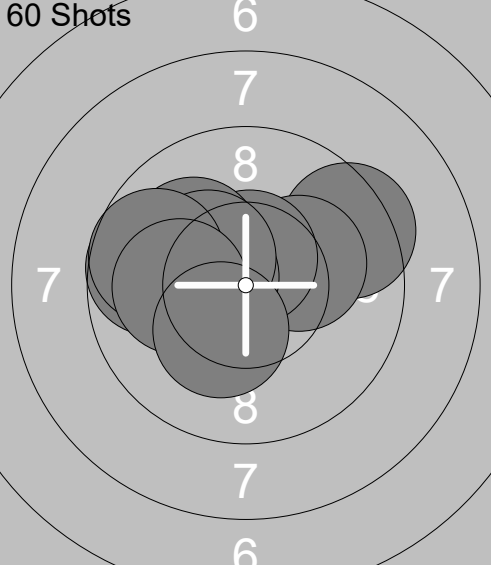
<p>60 Shots</p> 	<p>1: 10.3x ↘ 2: 10.3x ← 3: 8.4 → 4: 9.3 ↑ 5: 10.2x ← 6: 9.4 ↑ 7: 10.0 ↑ 8: 9.7 → 9: 9.7 ↓ 10: 10.4x ↗</p> <p>Series 97.7 97.7</p>	<p>60 Shots</p> 	<p>11: 9.6 ↗ 12: 10.0 ↗ 13: 10.2x ↑ 14: 9.7 → 15: 10.0 ↓ 16: 9.6 ↑ 17: 9.2 ↗ 18: 9.8 ↗ 19: 10.0 ↗ 20: 10.1 ↓</p> <p>Series 98.2 195.9</p>
<p>60 Shots</p> 	<p>21: 8.8 → 22: 10.1 ↓ 23: 9.6 → 24: 10.1 ↑ 25: 9.6 ↓ 26: 10.8x ↑ 27: 10.5x ↓ 28: 9.7 ↖ 29: 10.2x ↗ 30: 10.4x ↑</p> <p>Series 99.8 295.7</p>	<p>60 Shots</p> 	<p>31: 10.5x → 32: 9.8 → 33: 10.6x ↓ 34: 10.3x → 35: 9.6 ↖ 36: 10.5x ↑ 37: 10.3x ↗ 38: 10.3x ↖ 39: 10.3x → 40: 10.1 →</p> <p>Series 102.3 398.0</p>
<p>60 Shots</p> 	<p>41: 10.0 ↖ 42: 9.6 ↗ 43: 7.9 ↖ 44: 10.2x ↖ 45: 9.8 ↑ 46: 9.7 ↑ 47: 9.7 → 48: 10.4x ↓ 49: 10.1 ↑ 50: 10.1 ↓</p> <p>Series 97.5 495.5</p>	<p>60 Shots</p> 	<p>51: 9.4 ↗ 52: 10.2x ↗ 53: 9.7 ↖ 54: 10.6x ↑ 55: 10.1 ↖ 56: 10.5x ↖ 57: 10.3x ↖ 58: 9.7 ↖ 59: 10.1 ↖ 60: 10.3x ↓</p> <p>Series 100.9 596.4</p>

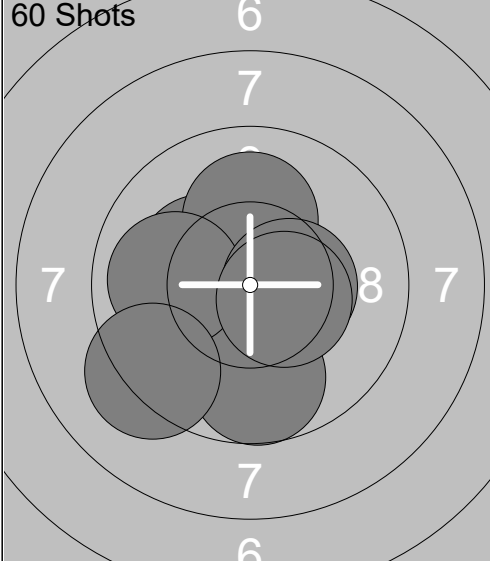
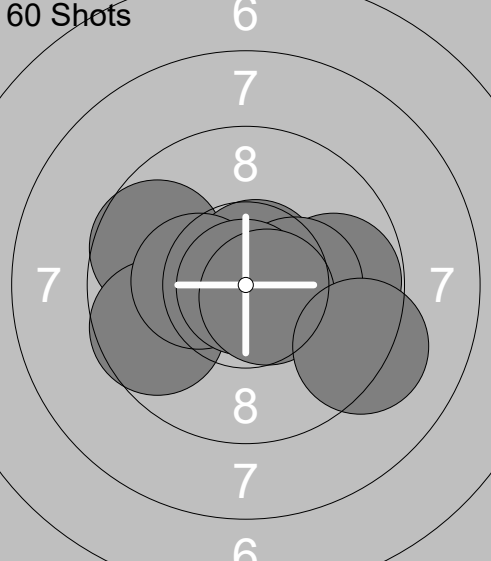
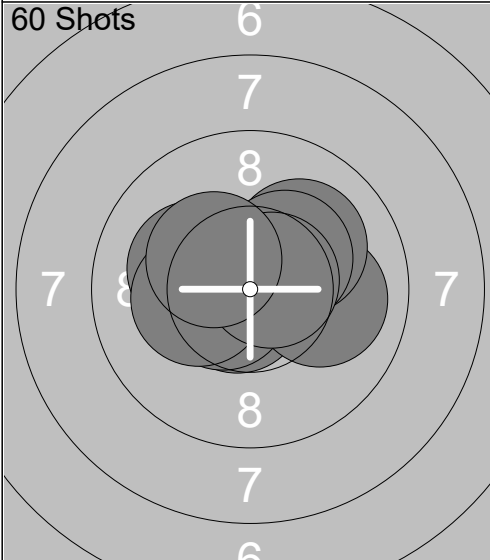
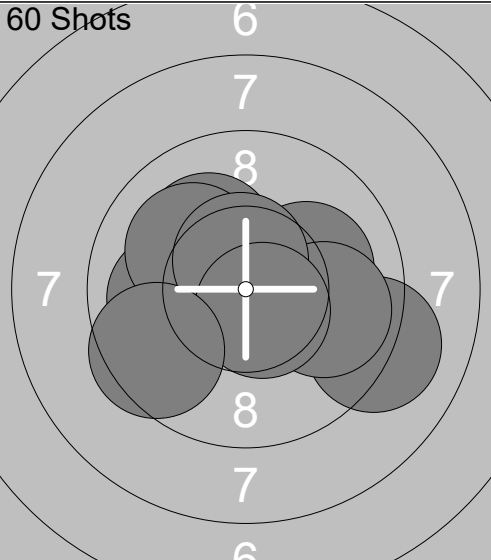
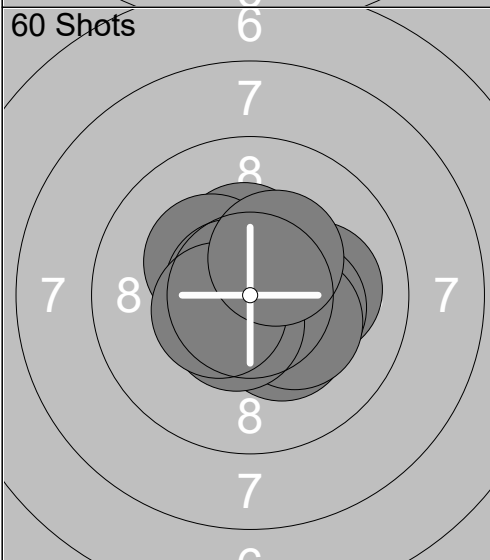
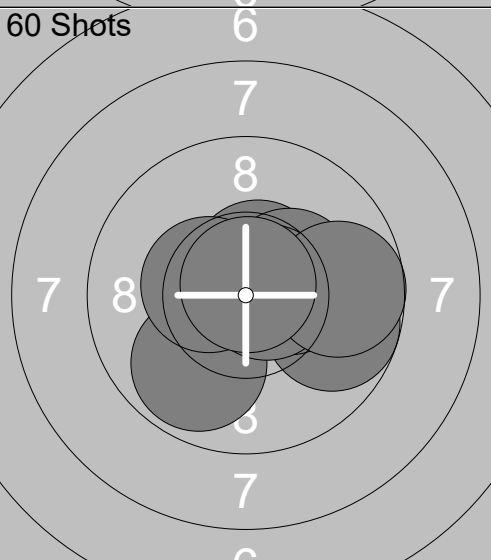
<p>60 Shots</p> 	<p>1: 10.3x ↙ 2: 10.6x → 3: 10.1 ← 4: 10.6x → 5: 10.1 ↑ 6: 9.7 ↓ 7: 10.0 ← 8: 10.4x → 9: 10.5x → 10: 9.2 ↙</p> <p>Series 101.5 101.5</p>	<p>60 Shots</p> 	<p>11: 9.7 ↙ 12: 10.8x ↙ 13: 10.7x ↗ 14: 9.7 ← 15: 10.3x ← 16: 9.8 → 17: 10.3x → 18: 10.9x ↙ 19: 10.6x → 20: 9.2 →</p> <p>Series 102.0 203.5</p>
<p>60 Shots</p> 	<p>21: 10.7x ↙ 22: 10.0 → 23: 10.1 ↗ 24: 10.7x ↙ 25: 10.3x ↗ 26: 10.2x ↙ 27: 10.6x ↙ 28: 10.3x ← 29: 10.6x → 30: 10.3x ↙</p> <p>Series 103.8 307.3</p>	<p>60 Shots</p> 	<p>31: 9.1 → 32: 10.1 → 33: 10.0 ← 34: 10.1 ↗ 35: 10.1 ↙ 36: 10.8x → 37: 9.9 → 38: 10.6x ↑ 39: 10.6x ↘ 40: 9.5 ↙</p> <p>Series 100.8 408.1</p>
<p>60 Shots</p> 	<p>41: 10.1 → 42: 10.3x ↘ 43: 10.4x ↑ 44: 10.3x ↙ 45: 10.3x → 46: 10.3x → 47: 10.7x ↙ 48: 10.5x ↘ 49: 10.5x ↙ 50: 10.4x ↗</p> <p>Series 103.8 511.9</p>	<p>60 Shots</p> 	<p>51: 9.7 → 52: 10.6x ↗ 53: 10.4x → 54: 10.3x → 55: 10.8x ← 56: 9.9 ↘ 57: 10.4x ← 58: 10.7x → 59: 9.7 → 60: 10.8x ↑</p> <p>Series 103.3 615.2</p>

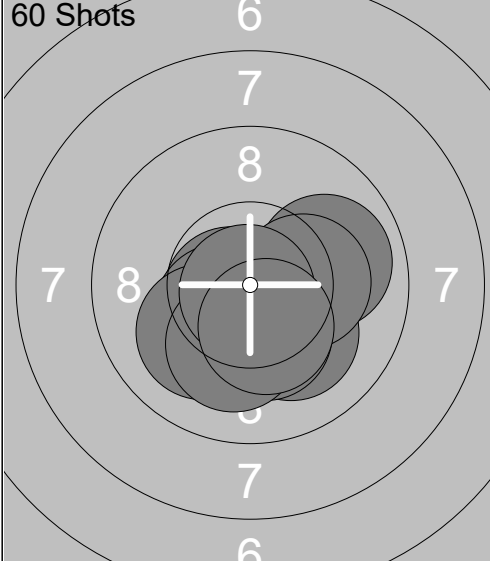
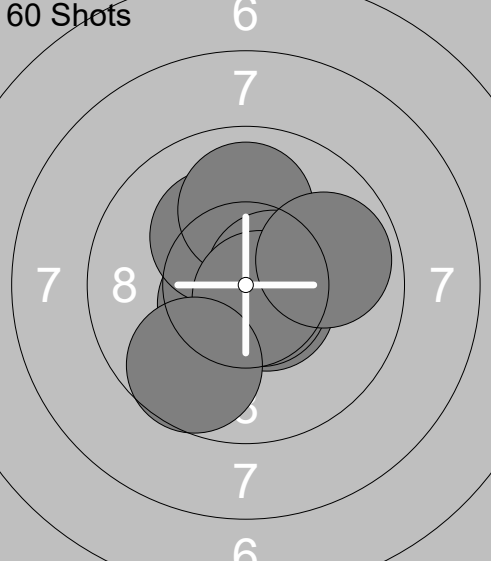
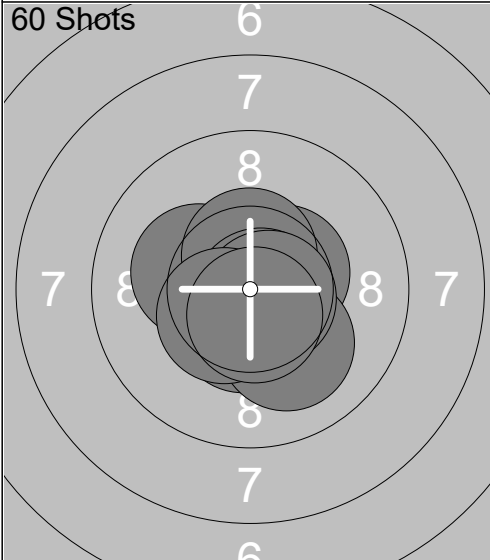
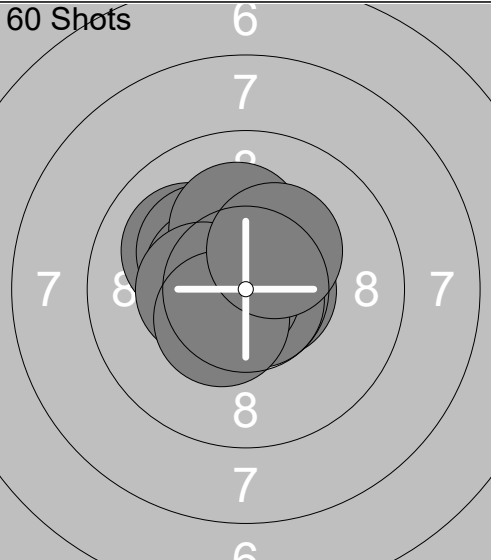
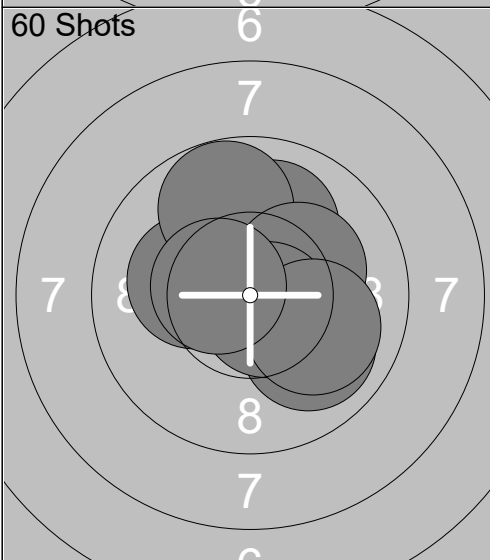
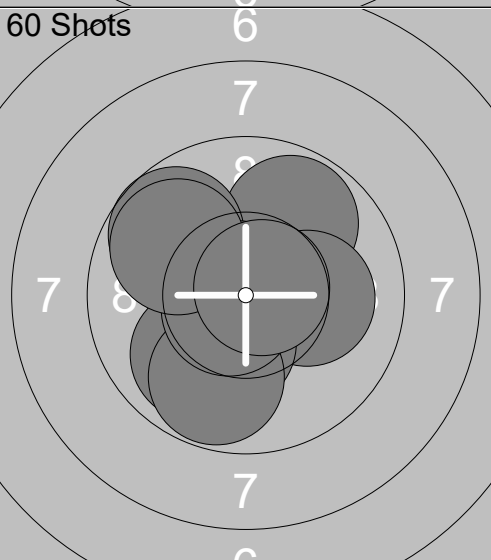
<p>60 Shots</p> 	<p>1: 10.1 ↘ 2: 10.7x ↙ 3: 10.4x ↙ 4: 9.9 → 5: 10.2x → 6: 10.1 ↙ 7: 10.3x ↓ 8: 10.1 ↓ 9: 10.8x ↓ 10: 10.4x ↓</p> <p>Series 103.0 103.0</p>	<p>60 Shots</p> 	<p>11: 10.6x ↑ 12: 10.8x → 13: 10.6x ↙ 14: 10.6x ↘ 15: 10.2x ↗ 16: 10.0 ↑ 17: 10.6x → 18: 10.7x ↘ 19: 9.7 ↓ 20: 9.9 →</p> <p>Series 103.7 206.7</p>
<p>60 Shots</p> 	<p>21: 10.5x → 22: 10.2x ↙ 23: 10.7x ↓ 24: 10.5x ↓ 25: 10.5x ↑ 26: 10.1 ↓ 27: 10.8x ↘ 28: 10.7x → 29: 10.5x ↙ 30: 10.6x ↓</p> <p>Series 105.1 311.8</p>	<p>60 Shots</p> 	<p>31: 10.6x → 32: 10.8x ↘ 33: 10.0 ↖ 34: 10.2x ↖ 35: 10.5x ↖ 36: 10.8x ← 37: 10.2x ↑ 38: 10.4x ← 39: 10.4x ↙ 40: 10.3x ↗</p> <p>Series 104.2 416.0</p>
<p>60 Shots</p> 	<p>41: 10.2x ↖ 42: 10.4x ↑ 43: 10.0 ↑ 44: 10.0 ↘ 45: 9.8 ↑ 46: 10.8x → 47: 10.2x → 48: 10.7x ↘ 49: 10.0 → 50: 10.5x ↖</p> <p>Series 102.6 518.6</p>	<p>60 Shots</p> 	<p>51: 9.8 ↗ 52: 9.7 ↖ 53: 10.1 → 54: 10.3x ↓ 55: 9.9 ↙ 56: 9.8 ↓ 57: 10.8x ↖ 58: 10.7x ↙ 59: 9.8 ↖ 60: 10.7x →</p> <p>Series 101.6 620.2</p>

Relay 6	Lane 23	Maddie Allen
-------------------	-------------------	---------------------

WVU Mobile Range			
------------------	--	--	--

18.11.2023	Walther Cup 2023	West Virginia University
------------	------------------	--------------------------

Comment	Signature
---------	-----------

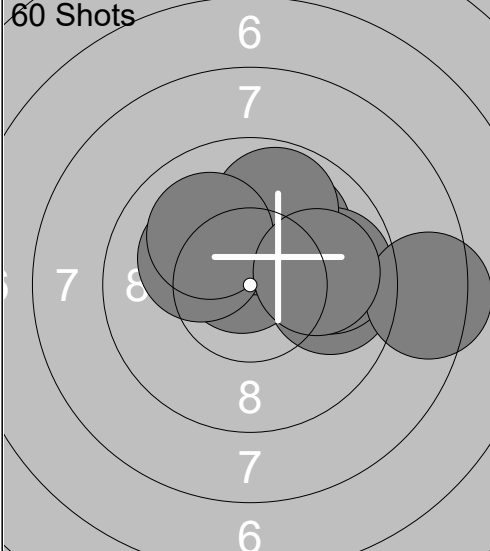
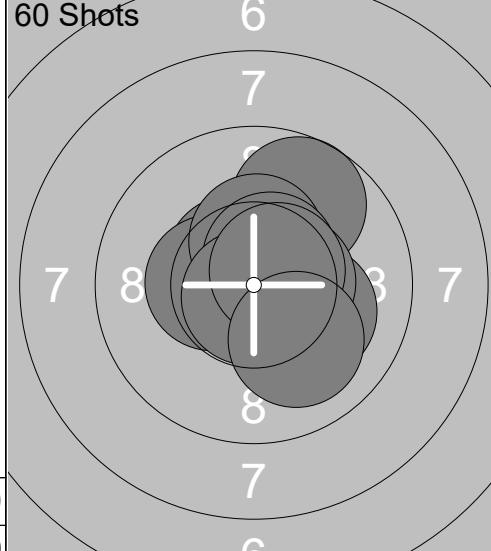
<p>60 Shots</p>  <p style="text-align: center;">6 7 8 7 6</p>	<p>1: 10.0 ↗ 2: 9.8 → 3: 10.7x ↖ 4: 10.2x ↑ 5: 9.8 → 6: 8.4 → 7: 10.2x ↖ 8: 9.8 ↑ 9: 10.0 ↖ 10: 10.0 →</p> <p>Series 98.9</p>	<p>60 Shots</p>  <p style="text-align: center;">6 7 8 7 6</p>	<p>11: 10.5x ↖ 12: 10.1 → 13: 10.4x ← 14: 9.7 ↑ 15: 10.4x ↑ 16: 10.5x ↗ 17: 10.8x ↓ 18: 10.5x → 19: 10.6x ↗ 20: 10.0 ↓</p> <p>Series 103.5</p>
98.9		202.4	

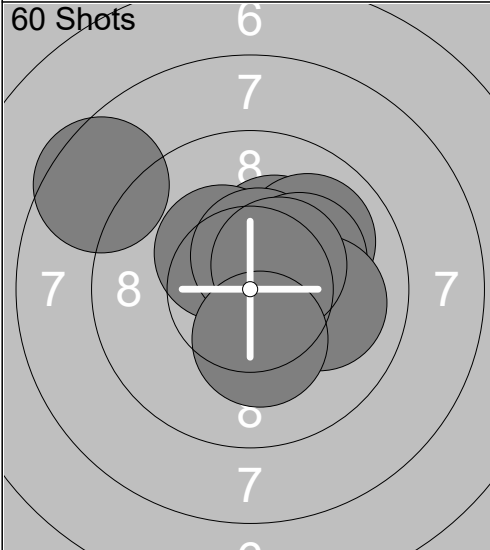
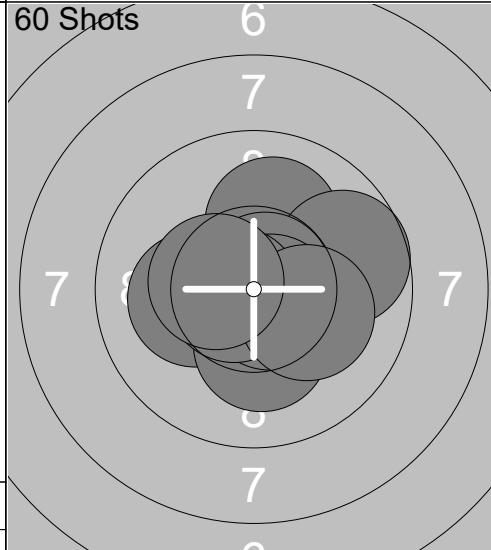
<p>60 Shots</p>  <p style="text-align: center;">6 7 8 7 6</p>	<p>21: 10.5x → 22: 10.3x ↗ 23: 10.3x ↖ 24: 10.0 ↗ 25: 8.5 ↖ 26: 10.5x ↑ 27: 10.2x ↗ 28: 10.0 → 29: 10.5x ↗ 30: 10.3x ↓</p> <p>Series 101.1</p>	<p>60 Shots</p>  <p style="text-align: center;">6 7 8 7 6</p>	<p>31: 10.1 ↑ 32: 10.2x ← 33: 10.5x → 34: 10.2x ↓ 35: 9.7 → 36: 10.8x ↗ 37: 10.7x ↓ 38: 10.7x ← 39: 10.2x → 40: 10.4x ←</p> <p>Series 103.5</p>
303.5		407.0	

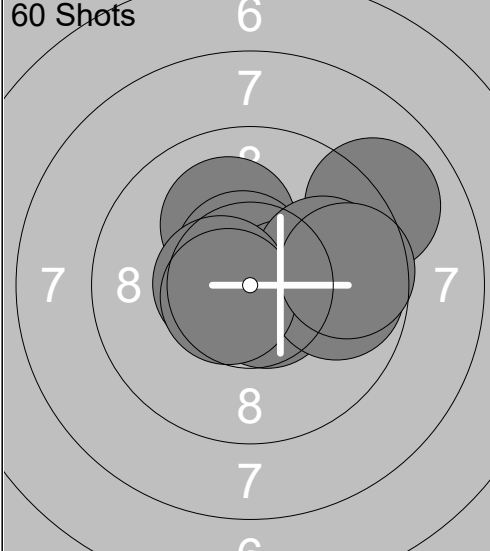
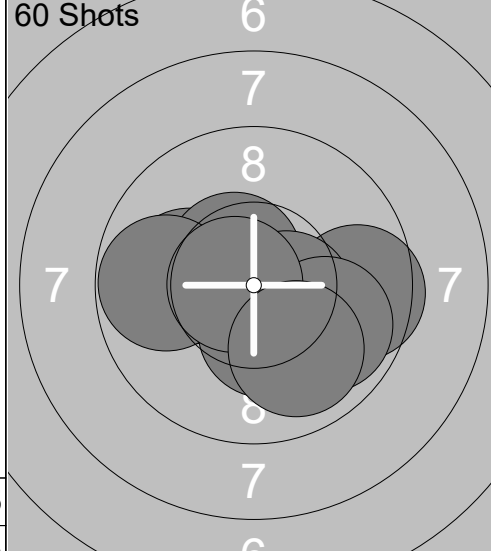
<p>60 Shots</p>  <p style="text-align: center;">6 7 8 7 6</p>	<p>41: 9.0 ↗ 42: 10.1 ↑ 43: 10.6x ↑ 44: 10.5x → 45: 10.7x ↓ 46: 9.9 → 47: 9.8 → 48: 10.6x ← 49: 10.6x ← 50: 9.7 →</p> <p>Series 101.5</p>	<p>60 Shots</p>  <p style="text-align: center;">6 7 8 7 6</p>	<p>51: 10.1 ← 52: 9.6 → 53: 10.8x ↖ 54: 10.5x ↗ 55: 10.3x ↓ 56: 10.5x → 57: 9.9 ↓ 58: 9.8 ← 59: 10.7x ← 60: 9.9 ↓</p> <p>Series 102.1</p>
508.5		610.6	

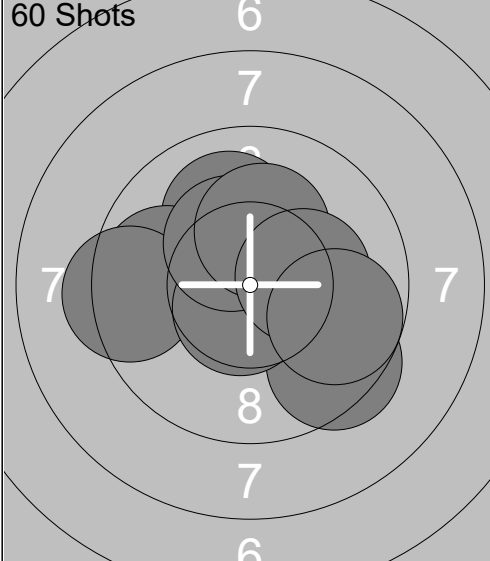
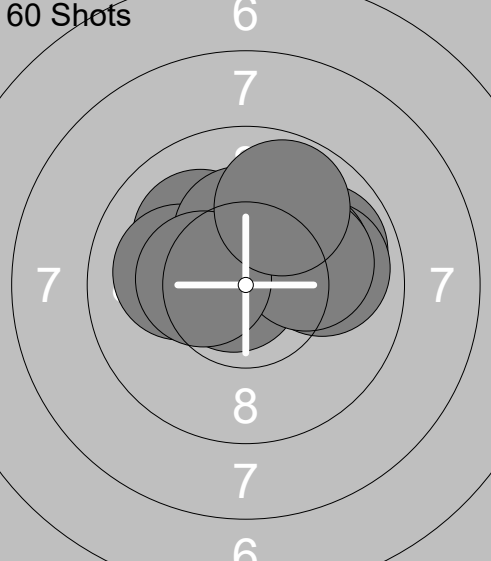
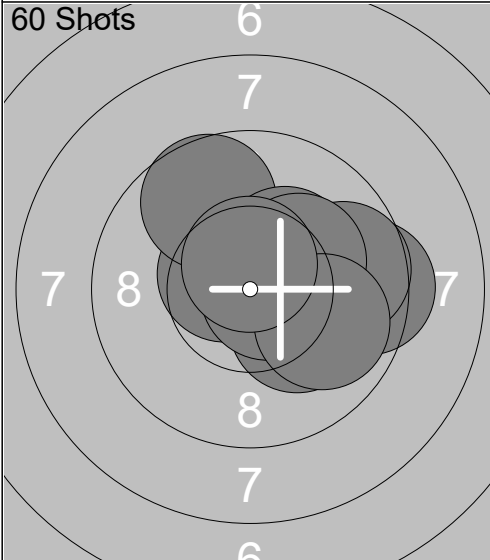
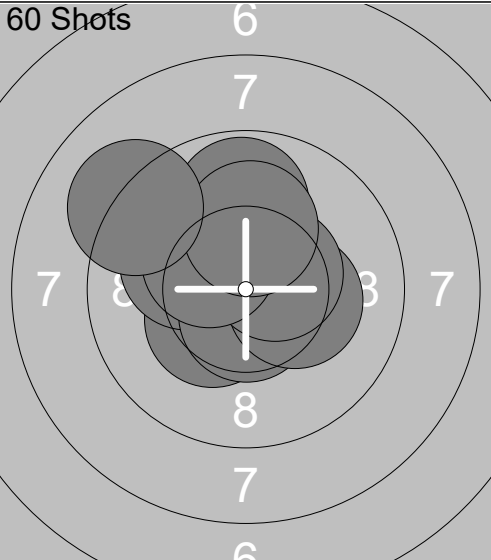
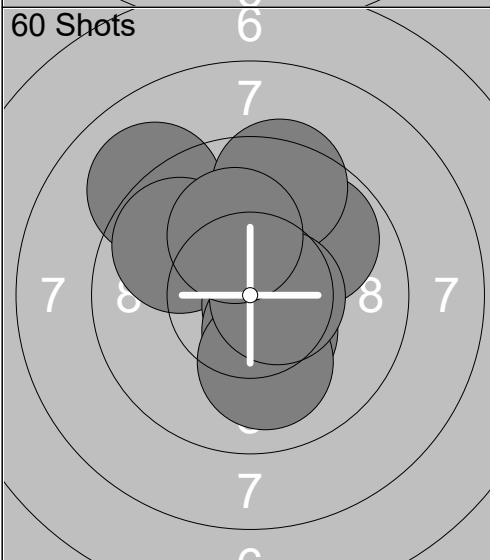
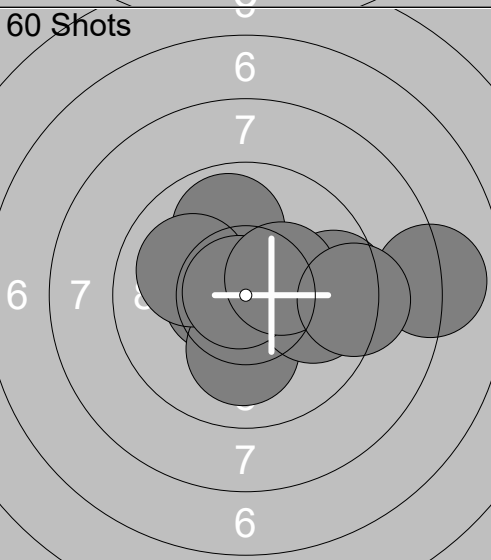
<p>60 Shots</p> 	<p>1: 10.0 ↑ 2: 9.4 ↘ 3: 10.8x ↓ 4: 9.8 ← 5: 9.4 ← 6: 10.6x ↓ 7: 10.3x ↑ 8: 10.2x ↑ 9: 10.2x → 10: 9.7 →</p> <p>Series 100.4 100.4</p>	<p>60 Shots</p> 	<p>11: 10.8x ← 12: 10.1 ↖ 13: 9.9 → 14: 9.9 → 15: 10.1 ← 16: 10.3x ↑ 17: 10.1 → 18: 10.1 → 19: 10.4x ← 20: 9.8 ↑</p> <p>Series 101.5 201.9</p>
<p>60 Shots</p> 	<p>21: 10.6x ↖ 22: 9.7 ↑ 23: 9.4 → 24: 10.2x ↘ 25: 9.7 → 26: 10.3x ↗ 27: 10.7x → 28: 10.2x ↗ 29: 9.9 → 30: 10.6x ↑</p> <p>Series 101.3 303.2</p>	<p>60 Shots</p> 	<p>31: 10.8x ↓ 32: 10.4x ↙ 33: 10.1 ↖ 34: 10.6x ↓ 35: 10.3x → 36: 9.8 ↑ 37: 10.5x ↗ 38: 10.3x ↖ 39: 10.1 ↑ 40: 9.1 ↖</p> <p>Series 102.0 405.2</p>
<p>60 Shots</p> 	<p>41: 9.1 ↗ 42: 9.8 ↖ 43: 10.7x ↗ 44: 10.7x → 45: 10.4x ↓ 46: 10.0 ↓ 47: 9.8 ↗ 48: 9.5 ↑ 49: 10.6x → 50: 10.1 ↑</p> <p>Series 100.7 505.9</p>	<p>60 Shots</p> 	<p>51: 9.9 ↑ 52: 10.5x ← 53: 10.1 ↓ 54: 9.6 → 55: 10.0 ↖ 56: 9.9 → 57: 10.8x ↖ 58: 8.0 → 59: 10.3x ↗ 60: 9.2 →</p> <p>Series 98.3 604.2</p>

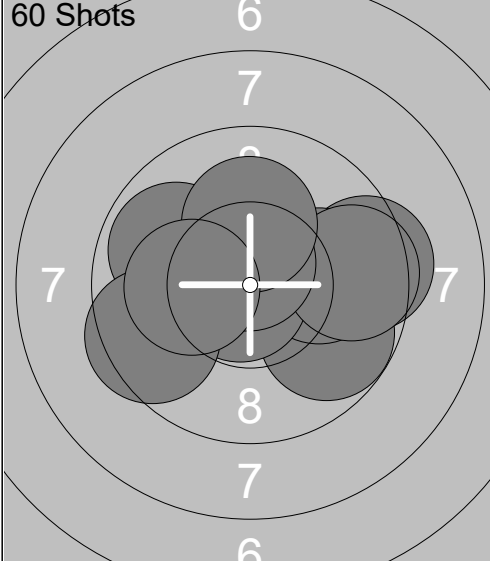
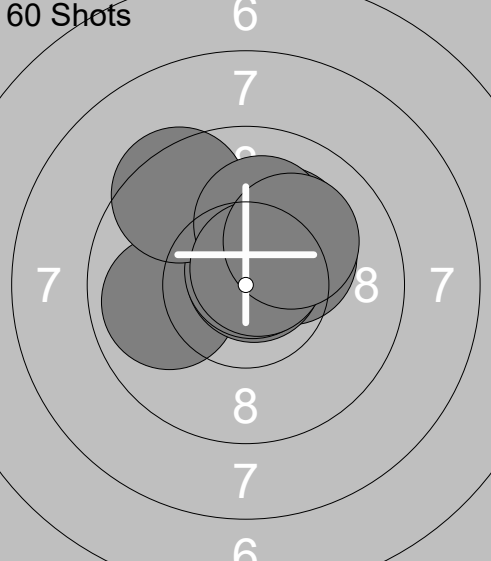
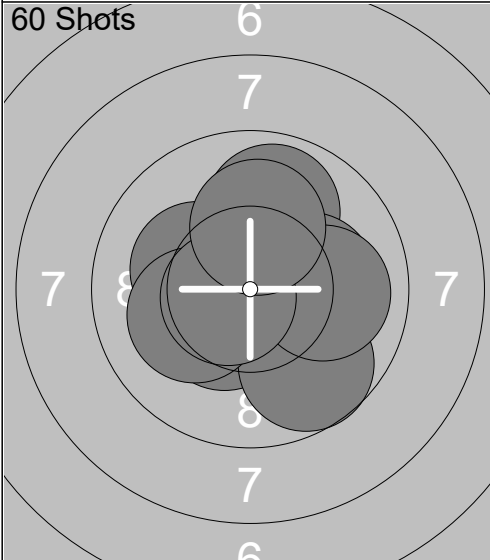
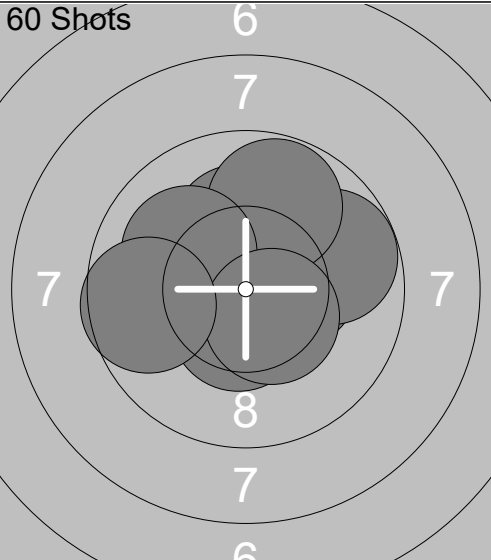
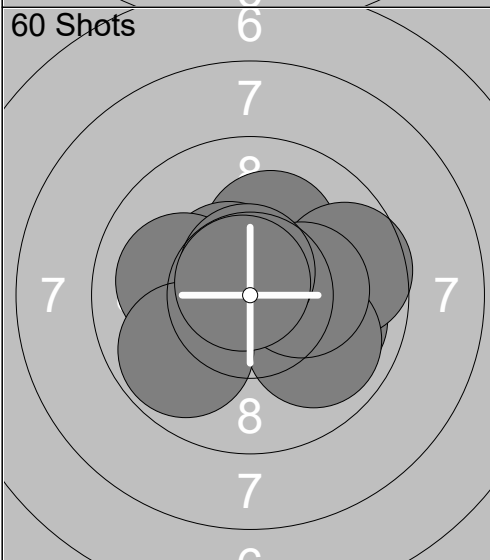
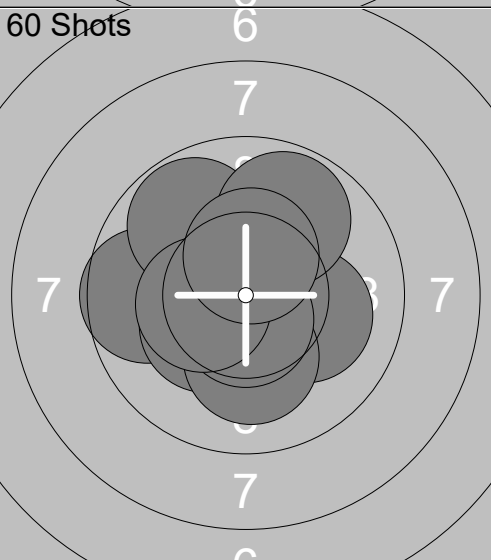
<p>60 Shots</p> 	<p>1: 9.8 ↘ 2: 9.4 → 3: 10.0 → 4: 10.8x ↙ 5: 9.9 ← 6: 9.6 → 7: 9.5 ← 8: 10.7x ↑ 9: 10.1 ↑ 10: 10.2x ←</p> <p>Series 100.0 100.0</p>	<p>60 Shots</p> 	<p>11: 10.1 ↗ 12: 9.9 ← 13: 10.3x ↗ 14: 10.8x ↗ 15: 10.4x ↗ 16: 10.7x ↗ 17: 9.5 ↖ 18: 10.1 ↑ 19: 10.7x ↗ 20: 10.1 ↗</p> <p>Series 102.6 202.6</p>
<p>60 Shots</p> 	<p>21: 10.4x ↙ 22: 9.9 ↑ 23: 10.2x ← 24: 10.2x → 25: 10.4x → 26: 9.7 ↘ 27: 10.1 ← 28: 10.0 → 29: 10.6x ← 30: 10.1 ↑</p> <p>Series 101.6 304.2</p>	<p>60 Shots</p> 	<p>31: 10.1 ↖ 32: 10.2x ↑ 33: 10.8x ↓ 34: 10.3x → 35: 10.5x ↓ 36: 9.8 → 37: 9.8 ↑ 38: 10.1 ↖ 39: 10.5x ↓ 40: 9.6 ←</p> <p>Series 101.7 405.9</p>
<p>60 Shots</p> 	<p>41: 10.2x ↑ 42: 10.5x ↗ 43: 10.0 → 44: 9.7 → 45: 9.9 ↘ 46: 10.3x → 47: 10.1 ← 48: 9.8 ← 49: 10.6x ↑ 50: 10.8x ↗</p> <p>Series 101.9 507.8</p>	<p>60 Shots</p> 	<p>51: 9.6 ← 52: 10.5x ↗ 53: 10.1 → 54: 10.3x ↙ 55: 9.8 ↖ 56: 10.1 ↓ 57: 10.6x ↓ 58: 10.4x ← 59: 9.8 ↑ 60: 10.4x ↑</p> <p>Series 101.6 609.4</p>

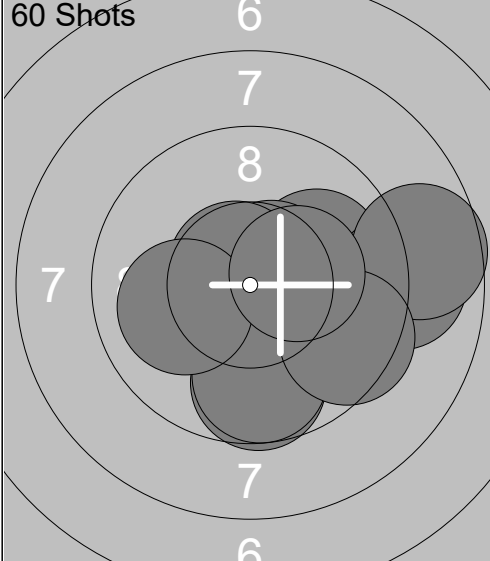
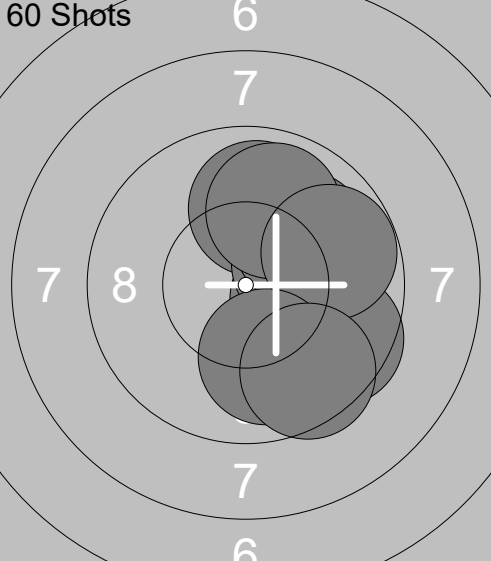
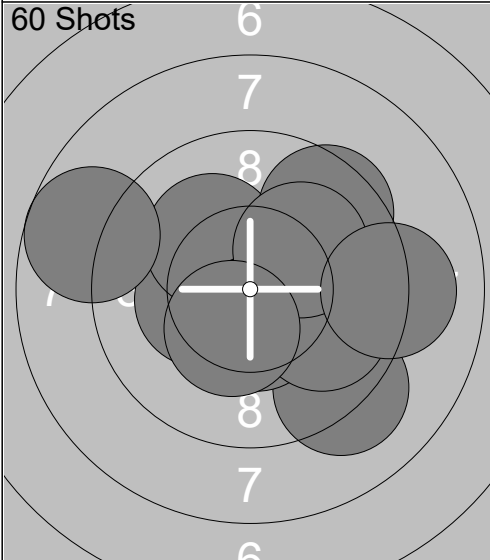
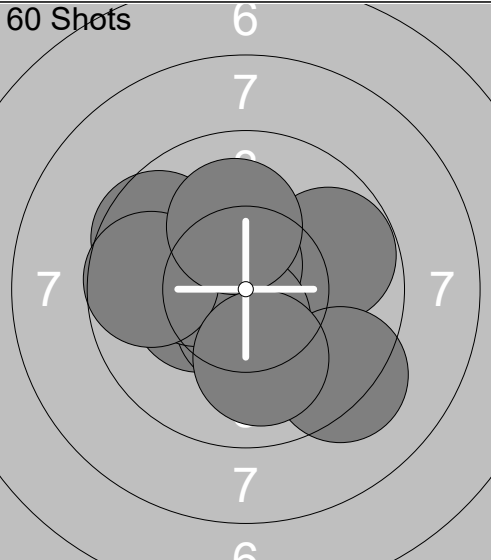
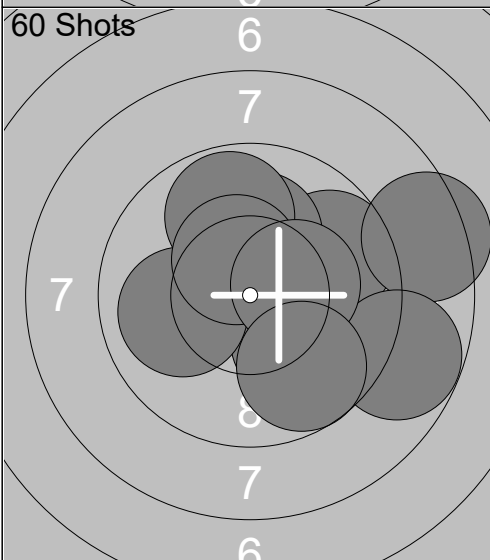
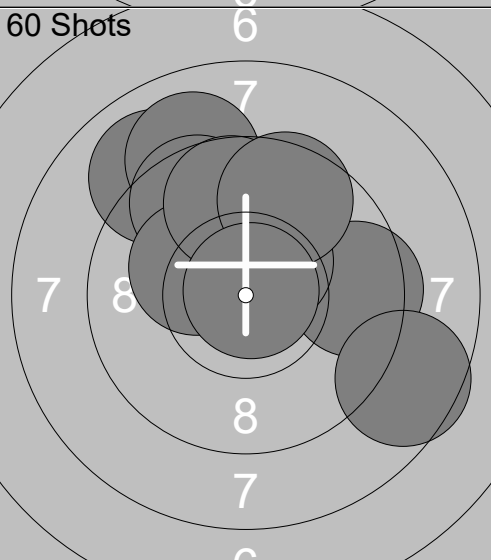
<p>60 Shots</p> 	<p>1: 10.0 → 2: 10.6x ↗ 3: 9.0 → 4: 10.7x ↗ 5: 8.7 → 6: 9.7 ↓ 7: 9.8 ↓ 8: 10.0 ← 9: 9.5 ↘ 10: 10.3x →</p> <p>Series 98.3 98.3</p>	<p>60 Shots</p> 	<p>11: 10.2x ⇒ 12: 10.2x ⇒ 13: 9.9 ↑ 14: 10.2x → 15: 10.0 ↗ 16: 9.9 ↑ 17: 9.6 ⇒ 18: 9.8 → 19: 10.0 ↓ 20: 9.5 ↓</p> <p>Series 99.3 197.6</p>
<p>60 Shots</p> 	<p>21: 10.3x ← 22: 10.1 ↗ 23: 9.5 ↗ 24: 9.2 ↓ 25: 10.5x ↓ 26: 9.9 ⇒ 27: 10.1 ↗ 28: 9.1 → 29: 10.4x ↓ 30: 8.7 ←</p> <p>Series 97.8 295.4</p>	<p>60 Shots</p> 	<p>31: 10.3x ← 32: 9.8 → 33: 9.6 ← 34: 10.6x ↑ 35: 9.3 ↓ 36: 10.5x ↓ 37: 10.3x ← 38: 9.7 ← 39: 10.1 ↑ 40: 10.0 ↓</p> <p>Series 100.2 395.6</p>
<p>60 Shots</p> 	<p>41: 10.1 ↓ 42: 9.7 → 43: 8.4 → 44: 10.0 ← 45: 10.1 ↑ 46: 9.8 ↑ 47: 8.8 ⇒ 48: 10.4x ↑ 49: 10.3x → 50: 9.7 ↓</p> <p>Series 97.3 492.9</p>	<p>60 Shots</p> 	<p>51: 9.5 → 52: 9.0 ↗ 53: 8.6 ⇒ 54: 9.0 ↑ 55: 10.4x ↑ 56: 9.6 ↑ 57: 10.2x ← 58: 9.7 ↑ 59: 9.6 ↑ 60: 10.9x ↗</p> <p>Series 96.5 589.4</p>

Relay 6	Lane 27	Lindsey Shaffer
-------------------	-------------------	------------------------

WVU Mobile Range			
------------------	--	--	--

18.11.2023	Walther Cup 2023	West Virginia University
------------	------------------	--------------------------

Comment	Signature
---------	-----------

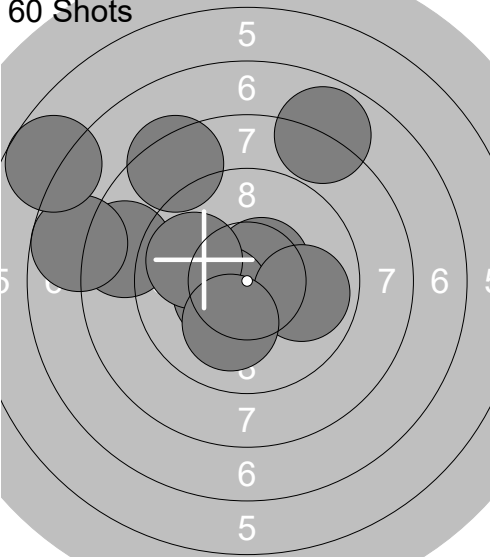
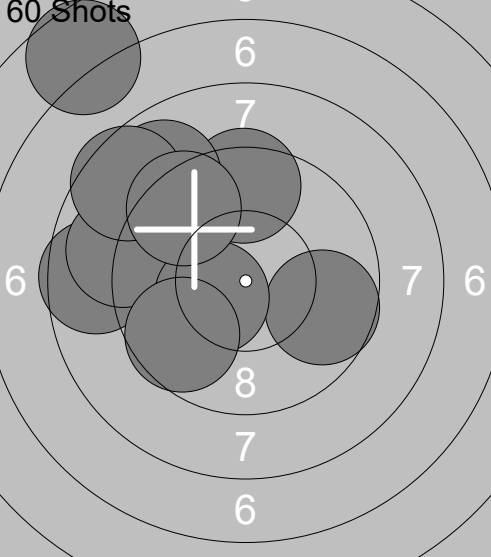
<p>60 Shots</p> 	<p>1: 8.6 ← 2: 7.9 ↗ 3: 7.7 ← 4: 10.6x ↗ 5: 10.4x ← 6: 9.9 → 7: 8.4 ↗ 8: 9.9 ↗ 9: 10.1 ↓ 10: 6.7 ↗</p> <p>Series 90.2 90.2</p>	<p>60 Shots</p> 	<p>11: 9.5 ↑ 12: 8.6 ← 13: 8.9 ↗ 14: 9.0 ← 15: 9.7 → 16: 6.6 ↗ 17: 10.4x ← 18: 8.5 ↗ 19: 9.5 ↗ 20: 9.6 ↙</p> <p>Series 90.3 180.5</p>
--	--	--	---

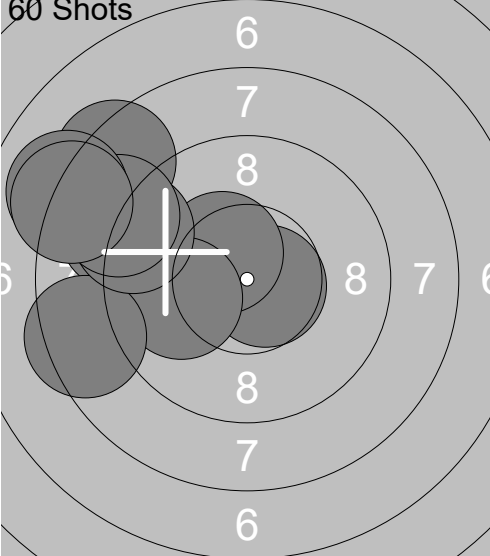
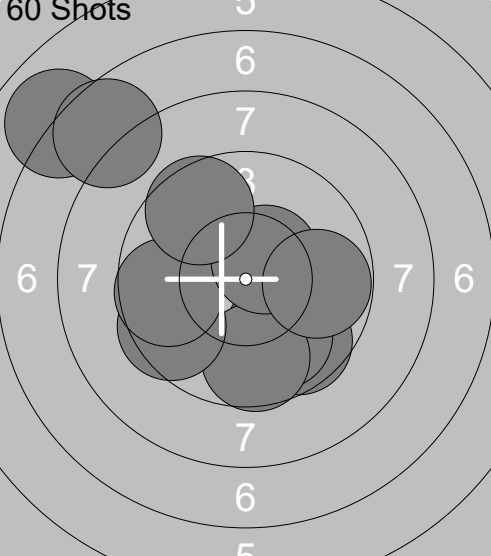
<p>60 Shots</p> 	<p>21: 10.7x → 22: 10.4x ↗ 23: 8.3 ↗ 24: 9.0 ↗ 25: 9.9 ← 26: 8.4 ← 27: 9.1 ↗ 28: 8.9 ↗ 29: 8.0 ↗ 30: 8.1 ←</p> <p>Series 90.8 271.3</p>	<p>60 Shots</p> 	<p>31: 9.6 ↓ 32: 9.9 ↓ 33: 9.7 ↓ 34: 6.9 ↗ 35: 9.5 ← 36: 9.7 ← 37: 10.5x ↗ 38: 9.6 ↗ 39: 7.6 ↗ 40: 9.8 →</p> <p>Series 92.8 364.1</p>
---	---	---	---

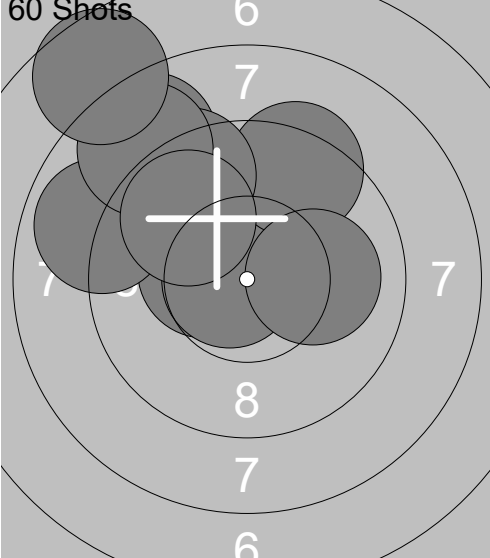
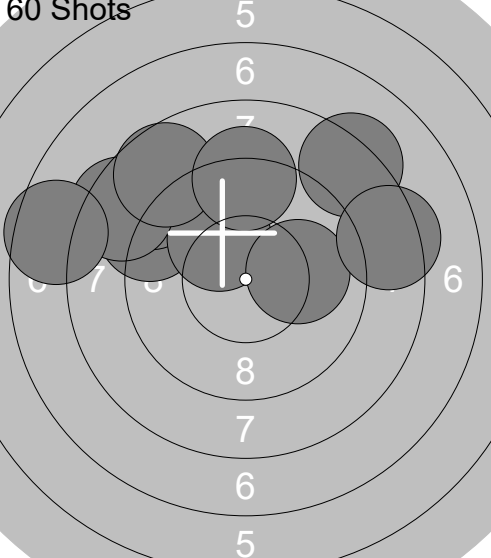
<p>60 Shots</p> 	<p>41: 10.4x ← 42: 10.7x ← 43: 9.4 ↗ 44: 8.7 ↗ 45: 8.9 ← 46: 9.4 ↗ 47: 8.8 ↗ 48: 9.8 ↗ 49: 10.1 → 50: 7.6 ↗</p> <p>Series 93.8 457.9</p>	<p>60 Shots</p> 	<p>51: 9.1 ← 52: 8.8 ↗ 53: 10.1 ↗ 54: 8.5 ↗ 55: 8.7 ↗ 56: 9.2 ↑ 57: 7.6 ← 58: 10.0 → 59: 8.3 ↗ 60: 8.4 →</p> <p>Series 88.7 546.6</p>
--	--	--	---

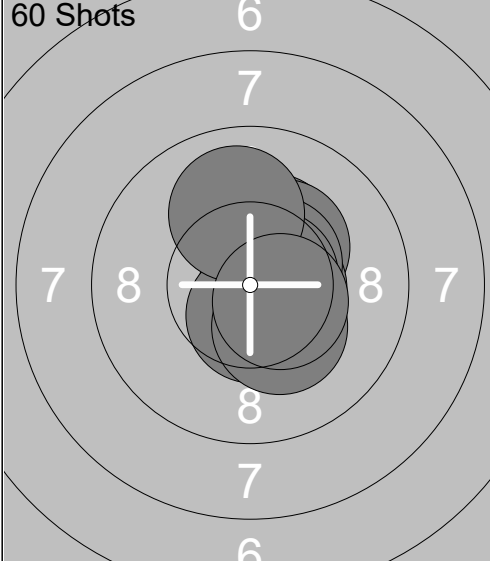
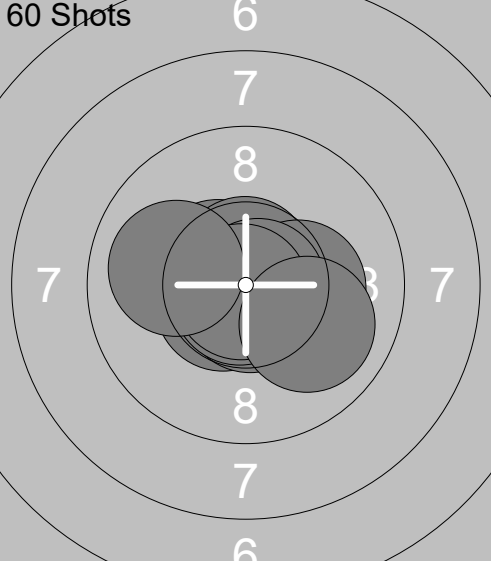
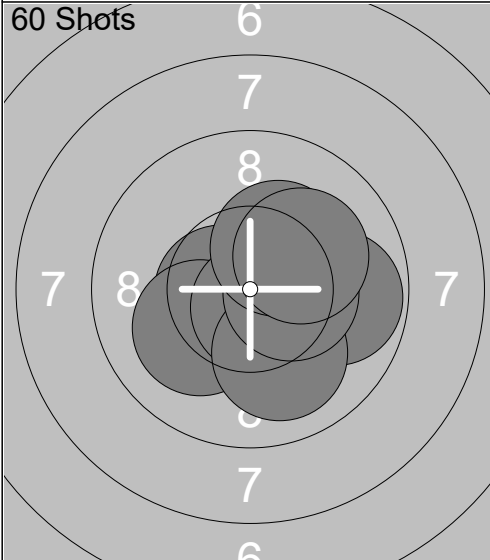
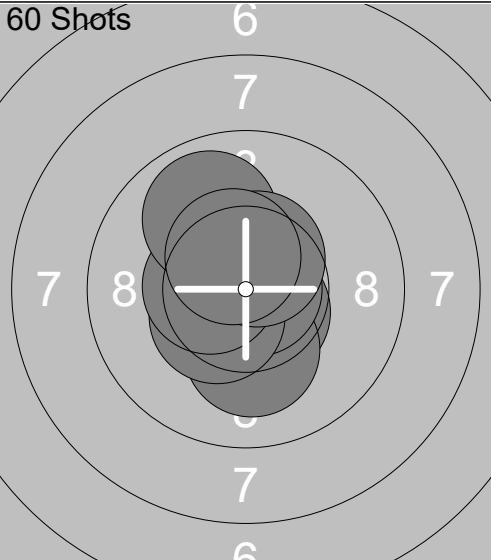
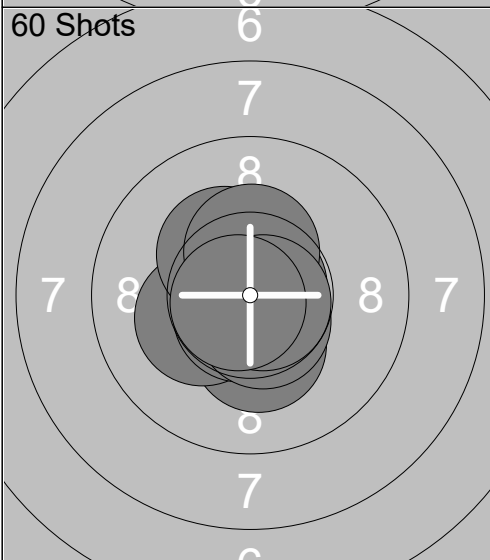
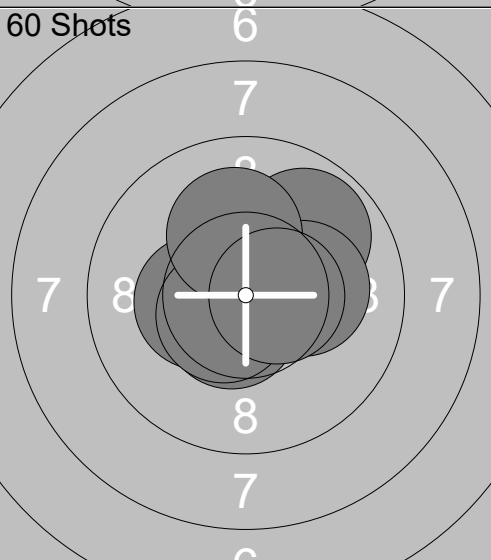
<p>60 Shots</p> 	<p>1: 10.3x ↗ 2: 10.3x ↗ 3: 10.6x → 4: 10.5x ↗ 5: 10.7x → 6: 10.7x → 7: 10.6x ↓ 8: 10.3x ↓ 9: 10.0 ↑ 10: 10.5x →</p> <p>Series 104.5 104.5</p>	<p>60 Shots</p> 	<p>11: 10.5x ↖ 12: 10.6x ↙ 13: 10.7x ↑ 14: 10.3x → 15: 10.7x ↓ 16: 10.8x → 17: 10.8x ↓ 18: 10.8x ↓ 19: 10.0 → 20: 10.0 ↖</p> <p>Series 105.2 209.7</p>
<p>60 Shots</p> 	<p>21: 10.9x → 22: 10.6x ← 23: 10.1 ↙ 24: 10.3x → 25: 9.8 → 26: 10.7x ↓ 27: 10.0 ↓ 28: 10.4x → 29: 10.3x ↗ 30: 10.1 ↗</p> <p>Series 103.2 312.9</p>	<p>60 Shots</p> 	<p>31: 10.6x ↓ 32: 10.2x ↓ 33: 10.7x ↖ 34: 10.8x → 35: 10.5x ← 36: 10.4x ↙ 37: 10.5x ← 38: 9.9 ↗ 39: 10.5x ↑ 40: 10.5x ↗</p> <p>Series 104.6 417.5</p>
<p>60 Shots</p> 	<p>41: 10.8x ↗ 42: 10.5x ↓ 43: 10.3x ↓ 44: 10.2x ← 45: 10.7x ↓ 46: 10.6x ↓ 47: 10.3x ↗ 48: 10.4x ↑ 49: 10.8x → 50: 10.8x ↙</p> <p>Series 105.4 522.9</p>	<p>60 Shots</p> 	<p>51: 10.9x → 52: 10.8x ↙ 53: 10.7x ← 54: 9.9 ↗ 55: 10.2x → 56: 10.4x ← 57: 10.6x ↓ 58: 10.6x ↙ 59: 10.1 ↑ 60: 10.5x →</p> <p>Series 104.7 627.6</p>

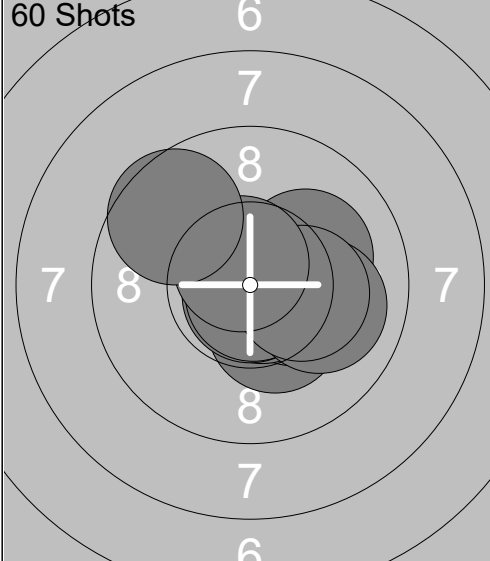
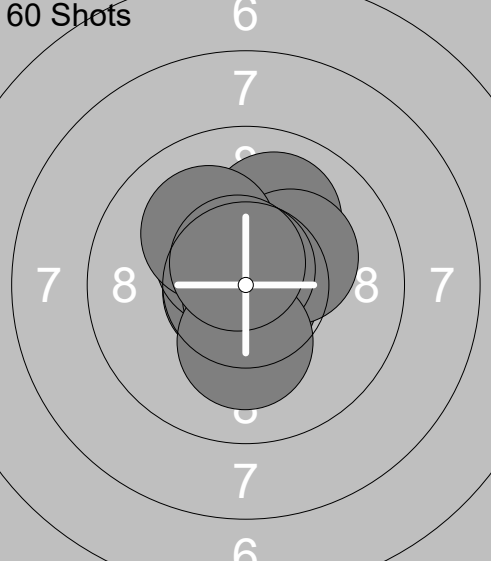
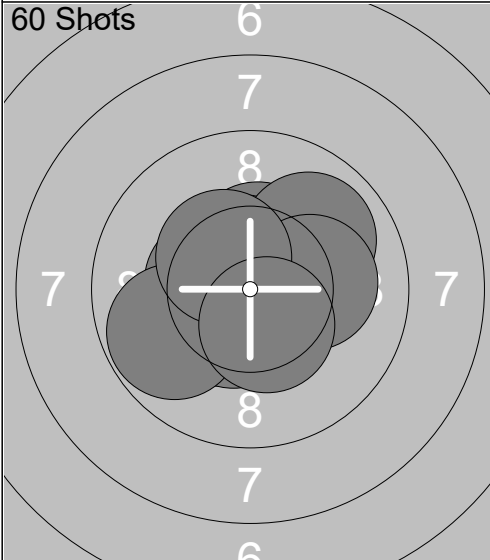
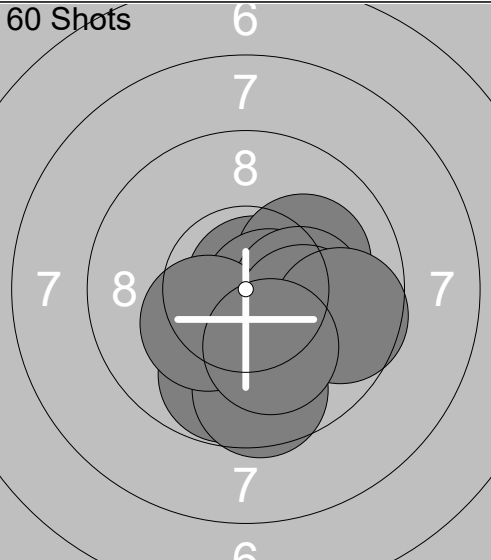
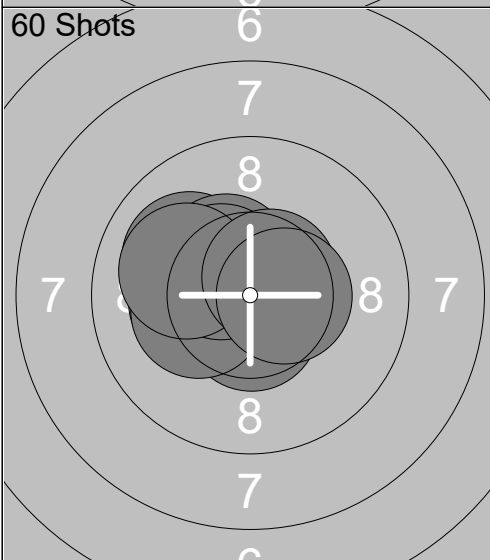
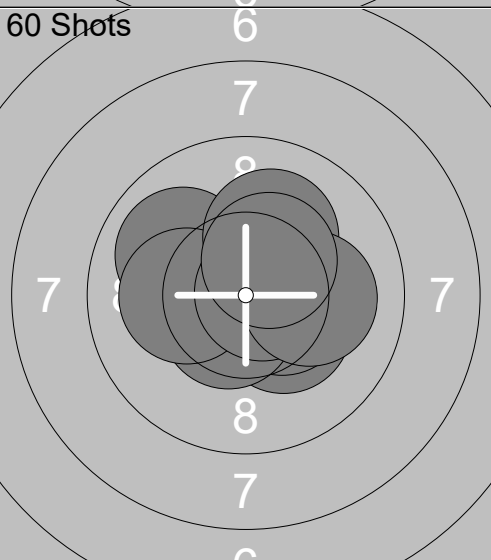
<p>60 Shots</p> 	<p>1: 10.3x ↘ 2: 10.1 → 3: 10.3x → 4: 10.7x ↘ 5: 10.8x ↓ 6: 10.8x ↓ 7: 10.0 → 8: 10.3x → 9: 10.6x ↑ 10: 9.6 ↗</p> <p>Series 103.5 103.5</p>	<p>60 Shots</p> 	<p>11: 10.7x ← 12: 10.5x ↖ 13: 10.8x ↓ 14: 10.2x ↑ 15: 10.0 ↑ 16: 10.2x ↗ 17: 10.1 ↖ 18: 10.7x ↑ 19: 10.2x ↓ 20: 10.6x ↖</p> <p>Series 104.0 207.5</p>
<p>60 Shots</p> 	<p>21: 10.3x ↙ 22: 10.4x ↑ 23: 10.5x ↓ 24: 10.4x ← 25: 10.6x ↑ 26: 9.8 ← 27: 9.9 ↗ 28: 10.2x → 29: 10.4x ↗ 30: 10.4x ↓</p> <p>Series 102.9 310.4</p>	<p>60 Shots</p> 	<p>31: 10.8x ↗ 32: 10.1 → 33: 9.8 ↓ 34: 10.6x → 35: 10.2x → 36: 9.6 ↓ 37: 10.3x ↙ 38: 10.1 → 39: 9.7 → 40: 10.1 ↓</p> <p>Series 101.3 411.7</p>
<p>60 Shots</p> 	<p>41: 10.0 ↖ 42: 10.6x ↓ 43: 10.6x ↗ 44: 10.4x ↖ 45: 10.2x ← 46: 10.2x ← 47: 10.5x ↖ 48: 10.1 ↖ 49: 10.6x ↗ 50: 10.5x →</p> <p>Series 103.7 515.4</p>	<p>60 Shots</p> 	<p>51: 10.3x ↘ 52: 10.6x ↖ 53: 10.4x → 54: 10.0 ↖ 55: 10.5x ↓ 56: 10.2x ← 57: 10.7x → 58: 10.1 ↑ 59: 10.1 → 60: 10.4x ↗</p> <p>Series 103.3 618.7</p>